

VERTICAL-WHEEL® BIOREACTORS

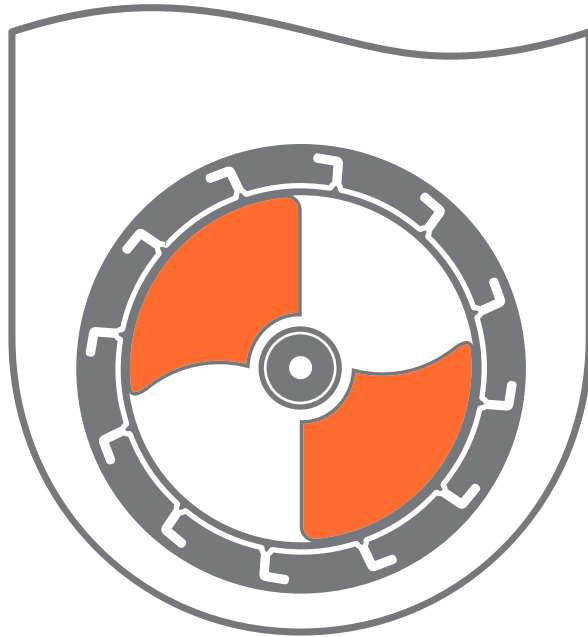

PBS-3 SUS Vertical-Wheel® Single-Use Sensors Single-Use Bioreactor System User Manual

Applicable Models: IA-3-B-711 | IA-3-B-712



PBS Biotech, Inc.

© 2026 PBS Biotech, Inc. All rights reserved. All text, images, graphics and other materials in this manual are subject to the copyright and other intellectual property rights of PBS Biotech, Inc.

Under the copyright laws, this manual may not be copied, in whole or in part, without written consent of PBS Biotech, Inc.

The marks appearing in this manual including, but not limited to: (i) PBS Biotech and the PBS Biotech logo; (ii) Vertical-Wheel® Bioreactor and its logo, emblem, slogans and model names and designs are trademarks of PBS Biotech, Inc., and registered in the U.S. and other countries.

Other company and product names mentioned herein may be trademarks of their respective companies. Mention of third-party products is for informational purposes only and constitutes neither an endorsement nor a recommendation. PBS Biotech, Inc. assumes no responsibility with regard to the performance or use of these products.

This User Manual reflects the latest product updates available at the time of publication. While every effort has been made to ensure accuracy, specifications and features may change. Please refer to the most recent product information on our website for the most up-to-date details regarding your bioreactor system.

PBS Biotech, Inc. is not responsible for printing or clerical errors.

This manual is intended as a guide to provide the user with necessary instructions on the proper use and maintenance of the PBS-3 SUS Bioreactor System. This manual should be used in conjunction with instruction and training supplied by qualified PBS Biotech, Inc. personnel.

Any failure to follow the instructions as described, including use of materials or products not approved or recommended by PBS Biotech, Inc., could result in impaired product function, injury to the user or others, or void applicable product warranties. PBS Biotech, Inc. accepts no responsibility for liability resulting from improper use or maintenance of its products.

Utilization of PBS Biotech, Inc. products may require the user to handle and dispose of biohazardous materials. Users must fully understand and implement all regulations regarding the safe handling of biohazardous products and waste, including the policies and procedures of their facility.

PBS Biotech, Inc.
4721 Calle Carga
Camarillo, California 93012
+1 (805) 482-7272
www.pbsbiotech.com

Contents

Preface	10	About This Manual
Chapter 1	11	PBS-3 SUS at a Glance
	11	Definitions
	12	PBS-3 SUS Bioreactor - Front
	14	PBS-3 SUS Bioreactor - Rear
	16	PBS-3 SUS Bioreactor - Sensors
	18	PBS-3 SUS Bioreactor - Gen2 Vessel
	22	PBS-3 SUS Bioreactor - Accessories
	24	PBS-3 SUS Hello User Interface
Chapter 2	26	System Description
	26	System Description
	26	Principles of Operation
	26	Agitation
	27	Heating
	27	Dissolved Oxygen
	27	pH
	27	Level
	27	Filter Oven and Condenser Bag
	28	Overview of PBS Software Functionality and Architecture
	28	Functionality
	28	Sensing and Control
	28	Data Acquisition and Reporting
	29	Process and Failure Alarms
	29	Task Automation
	29	Remote Monitoring and Control
	29	Administration
	29	Architecture
Chapter 3	31	Safety
	32	Supplier's Declaration of Conformity (USA)
	33	Inspections and Preventative Maintenance
	33	Inspections
	33	Preventative Maintenance
	33	Cleaning and Decontamination
	34	Lifting and Handling
Chapter 4	35	Product Specifications
	35	General
	35	Bioreactor Geometry
	35	Controls
	36	Agitation

	36	Gassing
	36	Temperature
	36	Dissolved Oxygen
	37	pH
	37	Level
	37	Pumps
	37	Single-Use Vessel
	38	Service Life
	38	Safety and Regulatory
Chapter 5	39	Installing the PBS-3 SUS
	39	Integrated Bioreactor
	39	Minimum Space Requirements
	39	Utility Requirements
	40	Unit Placement
	40	Connecting the Drip Collection Line
	40	Powering On the PBS-3 SUS
	41	Configuring Local Users and Groups
	42	Creating a New Local User Group
	44	Editing Local Group Permissions
	45	Editing Local Group Password Settings
	46	Creating a New Local User
	47	Modifying Local User Accounts
	48	Users' Own Accounts
	50	Naming the PBS-3 SUS
	52	Configuring Logger Settings
	55	Configuring Alarm Settings
	57	Configuring Email Function
	58	Configuring Sending Email
	59	Configuring Alarms Email List
	61	Configuring Automatic Backups
	62	Mapping Network Drives for Automatic Backup
	64	Scheduling Automatic Backups
Chapter 6	68	Using the PBS-3 SUS
	68	Before You Begin
	68	Suggested Order of Operations
	68	Set Up Run
	68	During Run
	69	End Run
	69	Before Starting a Batch Run
	69	Configure Optional Dip Tube and Tubing Assembly
	70	Autoclaving Optional Dip Tube
	70	Install Optional Dip Tube
	72	Log In to the Hello UI

74	Restarting the HMI Computer
76	Load Vessel
77	Install Vessel in PBS-3 SUS
81	Level 'Zero' Calibration
83	Starting a Run
83	Using the Pumps
84	Tube holder positioning
86	Tube loading
86	Using gravity
86	Accessing the Pumps menu
87	Adding Medium
88	Level 'Span' Calibration
89	Turning Controls On
92	'Span'/'One-Point' Calibrations After Equilibration
92	'Span' DO calibration
94	'One-point' pH calibration
95	Selecting a Base Pump
96	Adding Additional Fluids
97	Load the Alarms On.alm File
97	Inoculate with Cells
98	Entering Batch Name
100	Take Sample
100	PBS-3 SUS vessel's sample line
100	To take a sample with the vessel's sample line and a pump
104	To take a sample with the vessel's sample line, single-syringe pull, and gravity drain
106	To take a sample with the vessel's sample line and dual-syringe pull
109	To take a sample from the dip tube
110	Exchanging Medium
111	Harvesting a Run
112	Other Features
112	Filter Oven
112	Sequences
112	Creating or editing sequences
115	Running sequences
116	Generating Reports
120	Light
121	Advanced View
121	Shutdown
122	Alarms
123	Settings/System Variables
127	Sparging Oxygen

	127	Reboot RIO
	129	Other Calibrations
Chapter 7	130	Understanding the PBS-3 SUS
	130	Hello User Interface
	130	Interlocks
	130	Agitation
	131	Off Mode
	131	Manual Mode
	131	Auto Mode
	131	Lookup Mode
	131	Output Ranges
	131	Relevant Settings
	132	Interlocks
	132	Temperature
	132	Off Mode
	132	Manual Mode
	132	Auto Mode
	132	Sensor Error Mode
	133	Output Ranges
	133	Relevant Settings
	133	Interlocks
	134	Main Gas
	134	Relevant Settings
	134	Interlocks
	135	Dissolved Oxygen
	135	Off Mode
	135	Manual Mode
	136	Auto Mode
	136	Sensor Error Mode
	137	Output Ranges
	137	Relevant Settings
	138	Interlocks
	138	pH
	139	Off Mode
	139	Manual Mode
	140	Auto Mode
	140	Sensor Error Mode
	141	Output Ranges
	141	Relevant Settings
	142	Interlocks
	142	Level Sensing
	142	Relevant Settings

143	Filter Oven	
143	Off Mode	
143	Manual Mode	
143	Auto Mode	
143	Sensor Error Mode	
143	Output Ranges	
144	Relevant Settings	
144	Interlocks	
144	Control Pumps	
144	Types (Media and Additions A and B)	
145	Relevant Settings	
145	Interlocks	
145	Main Light	
145	Calibrating/Configuring Sensors	
145	Pre-Calibration Medium Conditioning Strategy	
148	Which Sensors Can Be Calibrated	
148	Dissolved Oxygen	
149	pH	
149	Level	
149	Temperature	
149	Filter Oven Temperature	
149	Calibration Types	
150	Zero	
150	Two-point	
151	Span and Offset	
153	Manual	
153	Sequences	
153	Actions and Looping	
154	Which Variable Types Sequences Can Change	
154	User Source	
154	System Source	
154	Sensor and Calculated Sources	
154	Other Information About Sequences	
155	Reports	
155	Types	
155	Process Data Recording	
156	Database	
156	Take Sample	
157	Sampling for Cell Counting	
157	Sampling for pH Measurement	
158	Sampling for DO Measurement	

	159	Load Vessel
	159	Batch
	159	Advanced View
	159	Windows/HMI Log Off
	159	Restart
	160	Alarms
	161	Settings
	161	User Accounts
	161	User Group Permissions
	161	Operation
	162	Process Configuration
	162	Advanced Configuration
	163	Administration
Chapter 8	164	Instructions for IT
	164	Bioreactor Computer Architecture
	164	Operating System
	165	BIOS
	166	Network Connections
	167	Configuring Domain Login
	167	To configure the bioreactor
	169	To configure the domain
	170	Configuring REST API Connectivity
	170	Configuring OPC UA Connectivity
	170	To configure the bioreactor
	173	Email
	175	Backups
	176	Manually Archiving DBs
	176	Automatic Updates
Appendix 1	178	Settings/System Variables
	178	Temperature
	179	Filter Oven
	181	Agitation
	183	pH
	188	DO
	192	Level
	193	Pressure
	193	Gas Data
	196	Safety
	198	Pumps
	198	Process Alarms
	200	System

Appendix 2	202	Alarms Definitions
Appendix 3	207	Default Alarms Configurations
Appendix 4	211	Default Logger Configurations and Global Variables Definitions
	211	Agitation
	212	Alarm
	213	Process Alarms/Limits
	217	Calibration
	219	DO
	222	Filter Oven
	224	Gases
	226	Interlocks
	227	LEDs
	227	Level
	227	pH
	230	Pumps and Valves
	232	Sequence/Recipe
	232	Logger
	233	System
	233	Temperature

About This Manual

This user manual shows you how to install, configure, and use the PBS-3 SUS Bioreactor System with the Single-Use Sensor configuration (PBS-3 SUS). This manual covers the Integrated Bioreactor, including the PBS Software package and the PBS-3 SUS Bioreactor Single-Use Vessel assembly.

The depicted vessel, and relevant instructions, are for the Gen2 vessel. The Gen1 vessel can still be used on the bioreactor system, and the earlier revision A of this user manual can be consulted for those instructions.

Configurations are standard as of the time of publication and the software features and instructions are applicable to version 4.2.x. The “Software Release Version” can be viewed in the “About” menu from the triple bar ≡ menu (top right corner).

The contents include:

- An overview of the PBS-3 SUS’s features, components, and controls (Chapter 1 on page 11)
- A high level system description to provide an understanding of the complete PBS-3 SUS (Chapter 2 on page 26)
- Safety considerations (Chapter 3 on page 31)
- Product specifications (Chapter 4 on page 35)
- Instructions for installing the PBS-3 SUS and configuring users, logger settings, and alarms (Chapter 5 on page 39)
- Day-to-day use of the PBS-3 SUS (Chapter 6 on page 68)
- A detailed description of all PBS-3 SUS features and functions (Chapter 7 on page 130)
- Information an IT department will need about the PBS-3 SUS (Chapter 8 on page 164)

Note: Screenshots are illustrative of the Hello UI features and are not intended to show actual or recommended settings.

For More Information

For Frequently Asked Questions and more troubleshooting information, visit the PBS Biotech website at www.pbsbiotech.com, then navigate to Resources → FAQ.

For specific questions, email app.eng@pbsbiotech.com.

Use the illustrations in this chapter to become familiar with the basic features, components, and controls of the PBS-3 SUS.

Note: Some components may be slightly different from the illustrations here, depending on the configuration you purchased.

Definitions

PV = Present Value

SP = Set Point

UI = User Interface

LPM = Liters Per Minute

mLPM = Milliliters Per Minute

mL/min = Milliliters Per Minute

RPM = Revolutions Per Minute

CO₂ = Carbon Dioxide

N₂ = Nitrogen

O₂ = Oxygen

IPA = Isopropyl Alcohol

EtOH = Ethanol

MFC = Mass Flow Controller

RIO = Reconfigurable Input/Output

HMI = Human Machine Interface

SUS = Single Use Sensor

BSC = Biosafety Cabinet

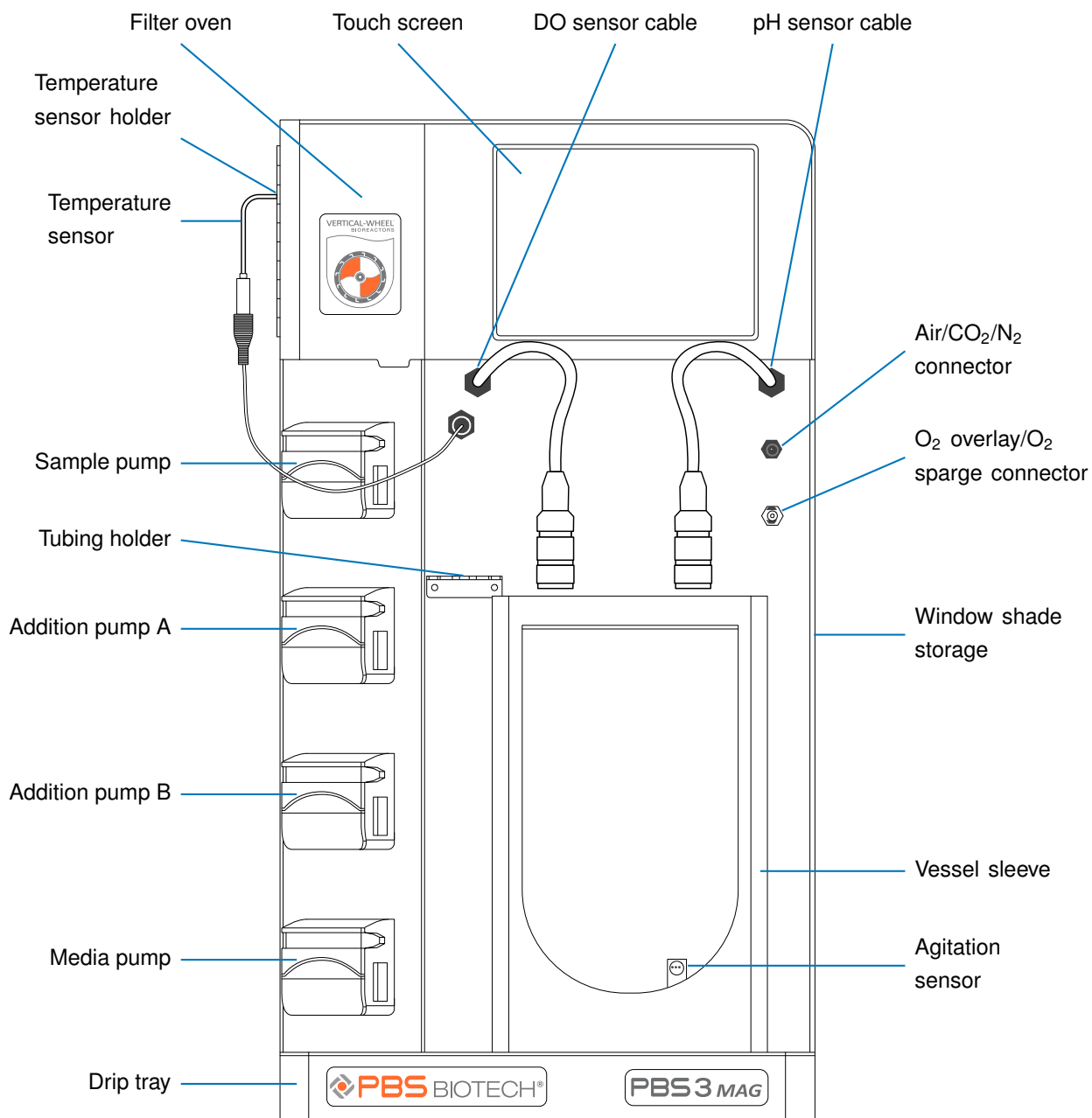

Filter oven

Keeps the exhaust filter at an elevated temperature to prevent clogging due to condensation of moisture from the exhaust gas.

Touch screen

Responds to bare fingers, latex/nitrile gloves, or a stylus.

DO sensor cable

Connects the DO sensor head to the bioreactor.

pH sensor cable

Connects the pH sensor and sensor head to the bioreactor.

Air/CO₂/N₂ connector

Connects the vessel's Air/CO₂/N₂ line to supplies of Air, CO₂, and N₂, which are attached to the bioreactor via the gas connection panel (see "PBS-3 SUS Bioreactor - Rear" on page 14).

O₂ overlay/O₂ sparge connector

Connects the vessel's O₂ overlay or O₂ sparge line to a supply of O₂, which is attached to the bioreactor via the gas connection panel (see "PBS-3 SUS Bioreactor - Rear" on page 14).

Window shade storage

Stores the Window shade by adhering to magnets in the PBS-3 SUS's side when not in use.

Vessel sleeve

Insulates the vessel, and when used with the Window shade, keeps it dark to protect light-sensitive media in the vessel. The sleeve must not be used to lift or carry the bioreactor - this could result in damage to the level sensor.

Agitation sensor

Detects agitation using the Hall effect by sensing when magnets on the Vertical-Wheel® impeller pass it.

Drip tray

Catches any media that leaks or overflows from the vessel. The media will then flow down a drain and into the drip collection line (see "PBS-3 SUS Bioreactor - Rear" on page 14).

Media pump

Used to fill or empty the vessel.

Addition pumps

Used with the vessel's addition tubing to add base and other supplements/additions during a run.

Sample pump

Used to draw a sterile sample from the vessel.

Tubing holder

Helps prevent the sample line and exhaust tubing from becoming kinked or tangled.

Temperature sensor

Installed in the thermal well in the vessel to provide accurate temperature readings.

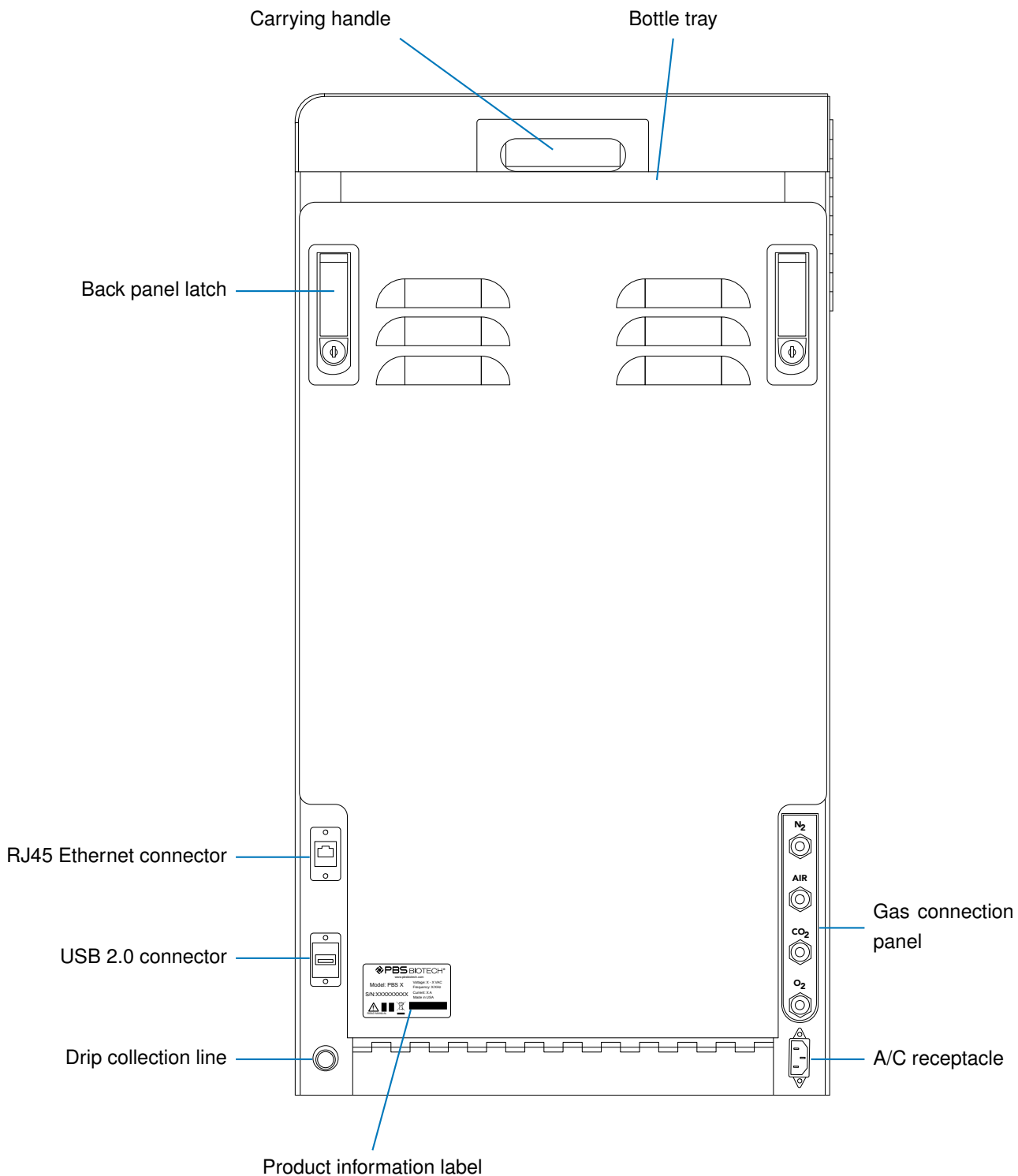

Carrying handle

Allows for convenience in moving the bioreactor.

Bottle tray

Stores reagent or media addition bottles during a run.

Gas connection panel

Connects the external N₂, Air, CO₂, and O₂ supplies to the bioreactor (for specifics, see “Utility Requirements” on page 39).

NOTICE The gas connectors on the back of the bioreactor are push-to-connect connectors. Disconnecting the tubing requires pushing in the orange or gray connector, then pulling out the tubing. Improper removal of tubing can break the retaining clip and impact the holding capability/seal when tubing is reinstalled.

A/C receptacle

Connects to a grounded outlet through a desired power cord to start up the bioreactor. There is no power switch on the bioreactor, to prevent it from being turned off accidentally.

Product information label

Displays the bioreactor’s serial and model numbers, as well as safety information.

Drip collection line

Connects to a drip collection container to catch overflow/spills from the vessel.

WARNING! As this is a gravity drain, ensure the collection container is below the level of the table and that the tubing runs downwards.

USB 2.0 connector

Allows connection of USB devices such as a keyboard, memory stick, or Wi-Fi adaptor.

NOTICE Avoid using keyboards with a power button, to prevent accidentally turning the bioreactor’s HMI computer off.

RJ45 Ethernet connector

Used to connect the bioreactor to a high-speed Ethernet network.

Back panel latch

Secures the bioreactor’s back cover and can be locked/unlocked with a supplied key.

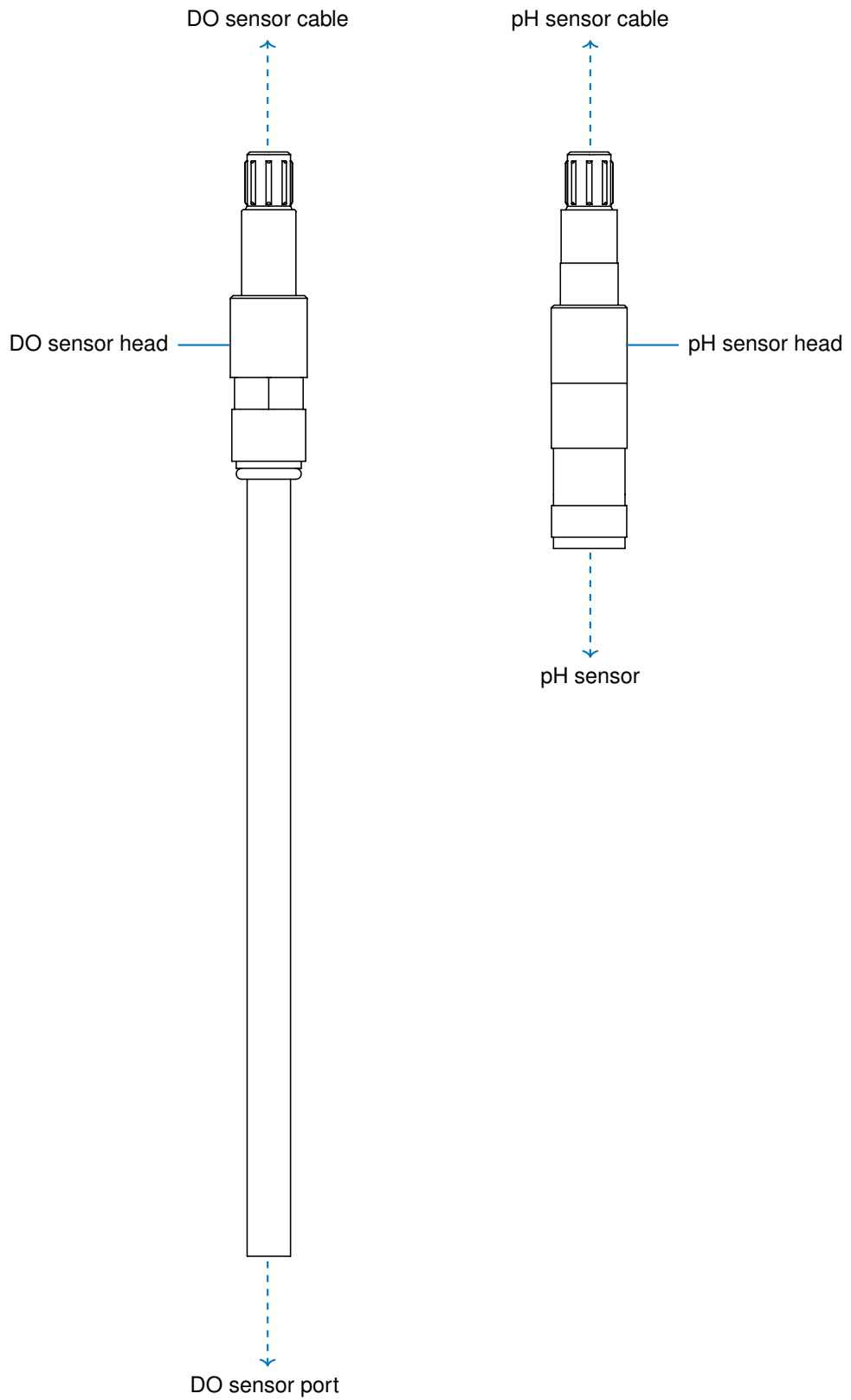

DO sensor head

Inserts into the DO sensor port pre-installed in the vessel and connects to the DO sensor cable on the bioreactor.

pH sensor head

Connects to the pH sensor pre-installed in the vessel and to the pH sensor cable on the bioreactor.

NOTICE The sensor heads are not single-use and need to be saved after a run. The user must disconnect the sensor heads from the vessel so as to not dispose of them when disposing of the vessel.

This drawing of the vessel is illustrative of general features and is not intended to represent any particular PBS product with 100% accuracy. Tubing lines, where they connect to the vessel or lid, do not have cable ties by design.

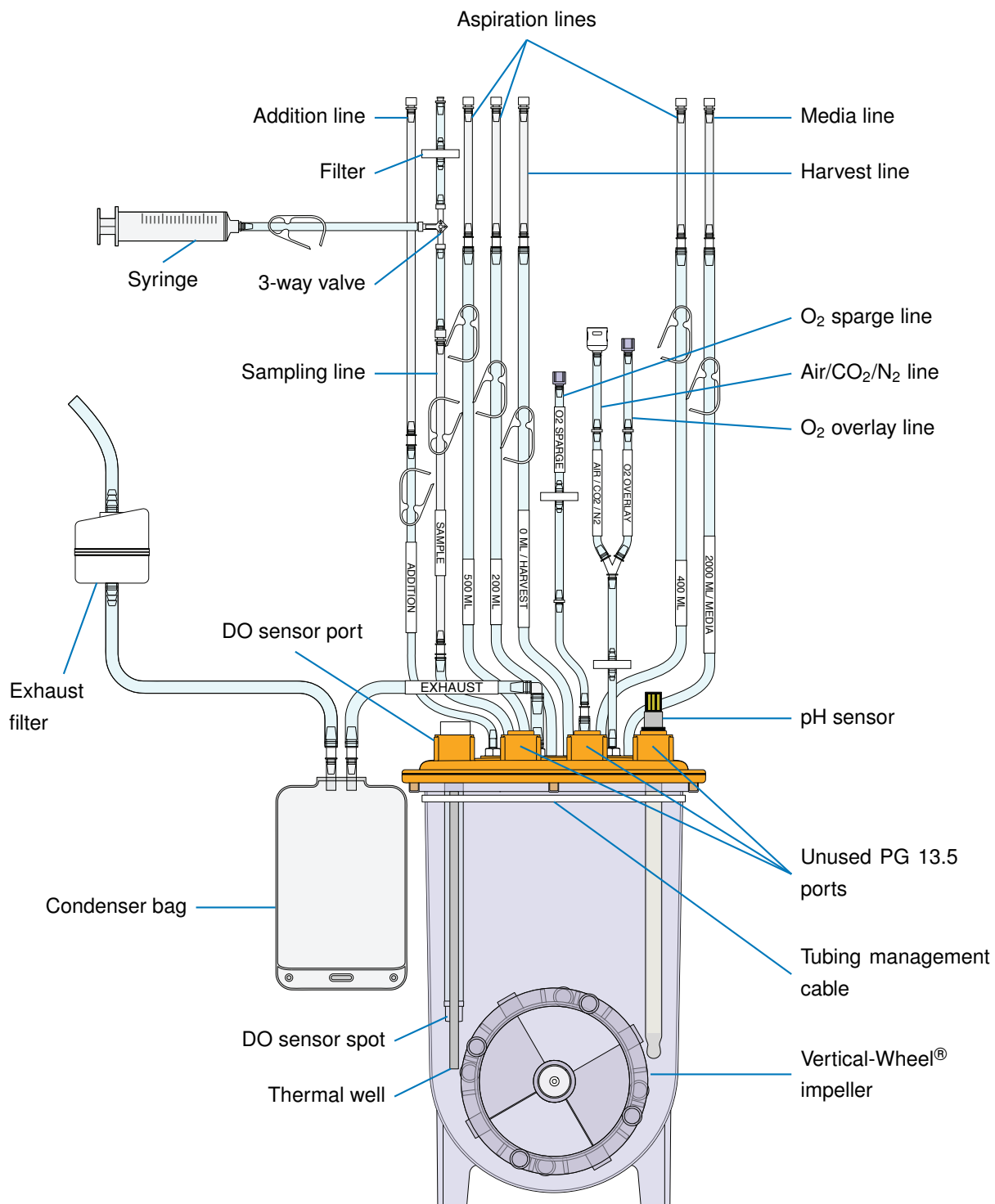

Sampling line

Used with the sample pump to remove a sterile sample and put it in the syringe. By manipulating the three-way valve and the pump correctly, sterile air from the filter is then used to clear the line to the syringe and back to the vessel.

Addition line

Used with an addition pump to add base and other additions from the top of the vessel during a run.

Aspiration lines

Used to draw a sample or remove spent medium during medium exchanges at the specified volume.

Media line

Used with the media pump to fill the vessel at the start of a run or to add medium during a medium exchange. If the vessel contains more than 2 L, the medium will be added below the liquid level line, minimizing splashing.

Harvest line

Used to empty the vessel during a harvest run, or to transfer the vessel's contents into a larger Vertical-Wheel® bioreactor. It is used with the media pump.

Air/CO₂/N₂ line

Connects to the bioreactor's Air/CO₂/N₂ connector, which connects to external gas sources via the gas connection panel (see "PBS-3 SUS Bioreactor - Rear" on page 14). Air, CO₂, and N₂ flow through this line to the overlay to control dissolved oxygen and pH.

O₂ overlay/O₂ sparge lines

Connect to the bioreactor's O₂ overlay/O₂ sparge connector, which connects to external gas sources via the gas connection panel (see "PBS-3 SUS Bioreactor - Rear" on page 14). O₂ flows through the O₂ overlay line to the overlay or through the O₂ sparge line to the sparger to control dissolved oxygen.

pH sensor

Comes pre-installed and sterilized in the vessel. The probe connects to the pH sensor head, which is then attached to the pH sensor cable on the bioreactor.

Unused PG 13.5 ports

Accommodate optional sensors or pieces of equipment, such as a dip tube.

Tubing management cable

This cable tie keeps the vessel's tubing aligned. It should not be removed. Make sure the head slides in to the closest corner of the sleeve, or the vessel will not slide all the way in.

Vertical-Wheel® impeller

Coupled to a driving motor by a set of magnets around its circumference. It has vanes for multidirectional mixing and a pair of magnets for RPM sensing.

Thermal well

Accommodates the temperature sensor to read the temperature of cell culture medium.

DO sensor spot

Comes pre-installed and sterilized in the vessel. Located at the tip of the DO sensor port sleeve. The spot works in conjunction with the DO sensor head to read the DO value of cell culture medium in the vessel. Shining a bright flashlight directly onto the DO sensor spot affects the DO PV.

DO sensor port

Allows insertion and removal of the DO sensor head while providing a sterile barrier for the vessel.

Condenser bag

Catches droplets entrained in the exhaust, preventing them from clogging the exhaust filter.

Exhaust filter

Filters the exhaust in order to maintain sterility of the vessel contents.

NOTICE Depending on the model of vessel being used, some of the tubing lines may not be compatible with the pumps installed on the PBS-3 SUS and will require the use of an external pump.

This page intentionally left blank.

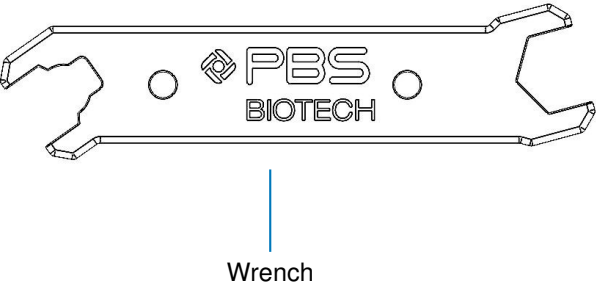
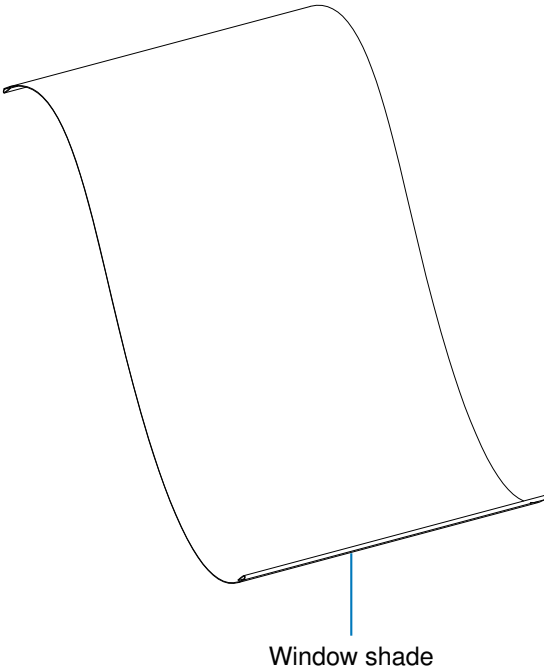
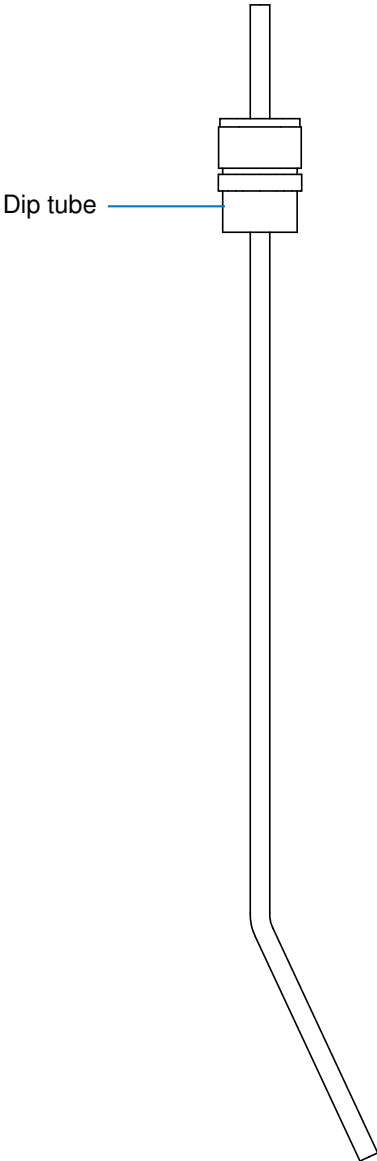

Dip tube

Used to remove spent medium, add liquids to the vessel, and take samples.

Window shade

Attaches to the sleeve to protect light-sensitive media in the vessel. Removable and stored by adhering to magnets in the PBS-3 SUS's side when not in use. If it gets lost or damaged, the replacement part number is IA-3-BA-001.

Wrench

Used for installing and removing port caps and accessories, such as the dip tube and sensors. If it gets lost or damaged, the replacement part number is IA-UNI-BA-005.

The Hello User Interface (Hello UI) opens automatically when the PBS-3 SUS is powered on. It contains all control panels, configurations, and other features needed to operate the bioreactor’s control system. For more information, see “Hello User Interface” on page 130.



Information bar

Shows the name of the current batch, the time the current batch was started, how long the current batch has been running, the name of the sequence currently running, the name of the loaded Alarm Settings file and number of enabled alarms, the name of the loaded Logger Settings file and number of enabled parameters, and the PBS-3 SUS name.

Side Menu

Displays additional menus.

Trend graphs



Show the agitation, temperature, DO, and pH PVs. The buttons below the graphs adjust the displayed time scale. Clicking on a graph brings up a full-screen graph menu, where graphs of Level, Filter Oven, and Gases are also visible.

Navigation tabs

Used to navigate to view Graphs, perform Actions, and view and acknowledge Alarms. The Alarms tab shows the number of unacknowledged alarms.

Dashboard

Consists of the “Agitation,” “Temperature,” “Dissolved Oxygen,” “pH,” and “Main Gas” buttons, along with two boxes showing the level and filter oven mode. The buttons show the present value, set point, and mode.

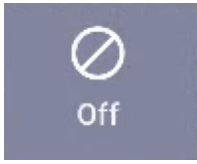
Mode Symbols	
Auto	
Manual	
Off	

Button/Box Color	Possible Causes
Gray	<ul style="list-style-type: none"> The PV is between the ‘Low’ and ‘High’ Process Alarm limits
Yellow	<ul style="list-style-type: none"> The PV is below the ‘Low’ Process Alarm limit The PV is above the ‘High’ Process Alarm limit
Red	<ul style="list-style-type: none"> The PV is below the ‘Low Low’ Process Alarm limit The PV is above the ‘High High’ Process Alarm limit The sensor is in an error state

This chapter gives an overview of the PBS-3 SUS Bioreactor System. It describes the high-level components and functionality of the PBS-3 SUS and explains the principles of basic operation.

System Description

The PBS-3 SUS Vertical-Wheel® Bioreactor System (PBS-3 SUS) is a single-use bioreactor intended primarily for the culture of mammalian cells and the production of cell-derived biologicals. It consists of a non-disposable PBS-3 SUS Bioreactor and a Vertical-Wheel® Bioreactor Single-Use Vessel Assembly (vessel). The PBS-3 SUS Bioreactor and vessel are designed to interface closely with each other and to function as an integrated system.

This PBS-3 SUS Vertical-Wheel® Bioreactor System provides all of the necessary process measurement and control features to ensure necessary conditions for the successful cultivation of cells. The PBS-3 SUS consists of: an interface for the vessel; an industrial controller; a four-gas module; a vessel heater; a vessel temperature sensor; DO and pH sensor heads for single-use sensors; a level sensor; sampling, medium, and addition pumps; a touchscreen interface; and an exhaust filter oven. It is able to control all critical cell culture parameters, such as agitation, temperature, DO, and pH.

The Vertical-Wheel® Bioreactor Single-Use Vessel is a uniquely shaped rectangular vessel with a round bottom incorporating the Vertical-Wheel® impeller, which has side paddles, vanes, and a hub. The vessel's shape is designed to work with the vertical impeller to offer excellent mixing and homogeneous particle suspension with very low shear stress using minimal power input. The vessel comes pre-installed with a DO port, DO sensor spot, single-use pH probe, and single-use thermal well.

Principles of Operation

Agitation

The PBS-3 SUS falls into the category of stirred bioreactors. The biggest difference between PBS Biotech's Vertical-Wheel® Bioreactors and traditional stirred bioreactors, whether single-use or reusable, lies in the unique vessel and impeller geometry, described above. The Vertical-Wheel® impeller is driven by a magnetically-coupled external motor.

Heating

The PBS-3 SUS has a built-in temperature sensor which, when inserted in the thermal well, senses the temperature of the vessel contents. The PBS-3 SUS also has permanently-mounted electric heaters positioned beneath the sleeve floor, which contacts the bottom surface of the vessel.

Dissolved Oxygen

The dissolved oxygen is monitored by a single-use DO sensor. Single-use sensors are intended to be calibrated with the PBS-3 SUS after the vessel has been filled with medium and equilibrated. The PBS-3 SUS controls the DO by using a two-sided PID (proportional-integral-derivative) controller. To decrease DO levels, the software increases the percent composition of N₂ flowing out of the Air/CO₂/N₂ connector, through the Air/CO₂/N₂ line, and into the overlay. To increase DO levels, the software flows O₂ out of the O₂ overlay/O₂ sparge connector, which either flows into the overlay via the O₂ overlay line, or is sparged through the medium via the O₂ sparge line.

pH

The culture pH is monitored by a single-use pH sensor. Single-use sensors are intended to be calibrated with the PBS-3 SUS after the vessel has been filled with medium and equilibrated. pH is usually regulated exclusively by CO₂%, and base should only be added if absolutely necessary. The PBS-3 SUS controls the pH by using a two-sided PID controller. To decrease the pH, the software increases the percent composition of CO₂ flowing out of the Air/CO₂/N₂ connector, through the Air/CO₂/N₂ line, and into the overlay. To increase pH, the software increases the duty of an addition pump that the user has selected to be the base pump, and supplied with a source of base.

Level

The weight of the vessel is continuously monitored by a load cell mounted inside the sleeve.

Filter Oven and Condenser Bag

As sterile gas flows into the vessel, it must also leave to prevent the vessel from over-pressurizing. Each vessel has an exhaust tubing line for this purpose. The exhaust tubing line has an in-line filter to maintain the sterility of the vessel contents. To prevent clogging of the exhaust filter, each vessel is equipped with a condenser bag on the exhaust tubing to catch entrained medium droplets, and the PBS-3 SUS has a temperature controlled oven to house the exhaust filter and prevent condensation of water vapor on the filter.

Overview of PBS Software Functionality and Architecture

Functionality

The PBS Software that is an integral part of your PBS-3 SUS is multifunctional. Its capabilities can be grouped in the following categories:

- Sensing and Control
- Data Acquisition and Reporting
- Process and Failure Alarms
- Task Automation
- Remote Monitoring (standard) and Control (add-on)
- Administration

Sensing and Control

The PBS-3 SUS has the ability to monitor and control agitation, temperature, dissolved oxygen, and pH in the vessel. It can also control the filter oven at a pre-determined temperature, as well as monitor the volume of the vessel contents. The four main control loops (agitation, temperature, DO, and pH) each have three user-selectable modes: Automatic, Manual, and Off. The main gas controller, which must be on for the DO and pH controls to function, only has a Manual and Off mode. In Automatic mode, the control loops implement PID feedback control with a set point determined by the user. In Manual mode, the control loops implement an open loop scheme where the user directly selects controller output. In Off mode, the controller's output is set to zero.

Also falling under the scope of Sensing and Control are interlocks, sensor error detection, and sensor error modes. The purpose of the interlocks is to prevent the creation of unsafe conditions or conditions that would hinder the growth of cells. The purpose of the sensor error detection and mode features is to minimize the problems that could arise due to sensor failure.

Data Acquisition and Reporting

The PBS Software has the ability to collect and report multiple types of data. Data types include Process Data, User Events, Alarms, Sequence Steps, and Errors. All these data types are stored to a database on the HMI computer's hard drive (see "Architecture" on page 29), and can be exported via email as .csv (comma-separated value) files. Process data includes over 300 variables. For each Process data variable, the user can select whether or not to log them, as well as how frequently to log them. The other data types always get logged to the database.

Process and Failure Alarms

To assist you in monitoring the performance of the PBS-3 SUS, a comprehensive set of parameters is continuously monitored. If any parameter falls outside of a pre-defined range, an alarm event will be generated and communicated to you. Process alarms monitor your process variables, while Failure alarms monitor the PBS-3 SUS's sensors and other hardware.

Each alarm can be individually configured to be displayed, made to sound a buzzer, emailed, or ignored. The sensitivity of the failure alarms can be configured by the user. In addition, the process alarm limits are entirely selectable by the user according to their particular process conditions.

Task Automation

Clicking “Sequence” from the “Actions” tab brings you to the menu used to activate the sequence engine.

The sequence engine allows the user to automatically run sequences of instructions on the PBS-3 SUS. The sequences are programmed using the Sequence Editor. Once saved, the sequences are available to be run from the Hello UI. Sequences can be used for a variety of tasks, such as setting all the controller modes and set points at once, or for changing a set point at some time in the future when no user will be present.

Remote Monitoring and Control

The default PBS software offers the ability to remotely monitor process parameters etc. via REST API. For more information, see “Configuring REST API Connectivity” on page 170.

There is also an optional add-on which allows for remotely monitoring and controlling the bioreactor via OPC-UA. For more information, see “Configuring OPC UA Connectivity” on page 170.

Administration

In addition to all of the above, the software allows the user to perform additional direct control functions, such as turning pumps on and off. It also offers the user administrative capabilities to add user accounts, configure user permissions, and configure system variables.

Architecture

The Vertical-Wheel® Bioreactor control system is a hybrid consisting of an industrial automation controller (the RIO controller) paired with a human

machine interface computer (HMI).









The RIO is in charge of all sensing and control functions, including interlocks, sensor error detection, and running sequences. If the HMI were to fail (from a software crash or hardware failure), the control loops, interlocks, and sequences would continue as normal and maintain current operating conditions.







The RIO is also in charge of the logic that captures the data points to be recorded, whereas the database engine and the database are on the HMI. If the HMI were to fail, data logging would stop, and would resume when the database engine resumed operation.

Finally, the RIO is in charge of detecting process and failure alarms, and the HMI communicates those alarms to the user. Alarm notifications would cease if the HMI were not to run.

NOTICE Users should not install additional software on the HMI without first consulting PBS Biotech Technical Support.

Review the following safety information before installing the system.

	<p>The PBS-3 SUS is intended for bench-top use. Ensure that the selected work surface has sufficient strength to safely carry the weight of the equipment plus any accessories and process materials.</p>
	<p>Customer-provided safety-straps may be used to reduce the risk of tipping or damage in the event of earthquake. Do not drill into the equipment or use screws to attach straps. Industrial-strength self-adhesive straps may be affixed to the metal sides of the system.</p>
	<p>If any PBS Biotech equipment is used with accessories not provided or recommended by PBS Biotech or used in a manner not specified by PBS Biotech, the protection provided by the equipment may be impaired.</p>
	<p>The power cord is the main electrical disconnect for the equipment. To remove power from the equipment, unplug the power cord. Do not position the equipment in such a way that it is difficult to unplug the power cord. Do not apply tension on the power cord, to avoid sudden electrical disconnects.</p>
	<p>To provide continued protection against risk of electric shock, the equipment must be connected to a properly grounded outlet. Only use power cords provided by PBS Biotech. Do not use an adapter.</p>
	<p>The back panel of the equipment must only be removed by a trained technician. High voltage circuits are accessible inside and there is a danger of lethal electric shock.</p>
	<p>Use caution when working near peristaltic pumps. Keep fingers, jewelry, loose clothing, etc. free of the rotating pumps to prevent injury.</p>
	<p>The PBS-3 SUS has hot surfaces, as indicated by hot surface warning signs. Do not touch hot surfaces.</p>

	Vertical-Wheel® Bioreactors are not designed for pressurized operation. Always allow the bioreactor vessel to vent. Never clamp the vessel outlet lines. This could result in dangerous pressure build-up in the vessel.
	Only use vessels manufactured by PBS Biotech for the specific model of your bioreactor system.
	Pumps may restart automatically if the power is restored after an interruption.
	When using external pumps to fill a vessel installed in the bioreactor, use precautions to ensure that the vessel will not overflow, which could cause dangerous pressure build-up.
	Biological substances, such as viruses, cells, and sera, have the potential to transmit infectious diseases. If biohazardous materials are used with this equipment, follow all applicable local, state/provincial, and/or national regulations, including identification of samples with the biohazard symbol. Wear appropriate protective eyewear, clothing, and gloves.
	If the equipment has been used in a biohazardous environment, it must be decontaminated according to all applicable local, state/provincial, and/or national regulations prior to any shipment, or disposal.
	Customers are to follow local regulatory guidelines for proper recycling and disposal of PBS products.

Supplier's Declaration of Conformity (USA)

FCC / 47 CFR § 2.1077 Compliance Information

Identification of Product: PBS 3

Responsible Party: PBS Biotech, Inc.
4721 Calle Carga
Camarillo, CA 93012 USA
1 (805) 482-7272

This device complies with Part 15 of the FCC Rules. Operation is subject to the following two conditions:

- (1) This device may not cause harmful interference, and
- (2) this device must accept any interference received, including interference that may cause undesired operation.

NOTICE The PBS 3 has been tested and found to comply with the limits for a Class A digital device, pursuant to part 15 of the FCC Rules. These limits are designed to provide reasonable protection against harmful interference when the equipment is operated in a commercial environment. This equipment generates, uses, and can radiate radio frequency energy and, if not installed and used in accordance with the instruction manual, may cause harmful interference to radio communications. Operation of this equipment in a residential area is likely to cause harmful interference in which case the user will be required to correct the interference at his own expense.

Inspections and Preventative Maintenance

Inspections

This section describes the inspections that the user should perform on the PBS-3 SUS Bioreactor system to verify safety mechanisms are functional. For instructions on inspecting a Vertical-Wheel® Bioreactor vessel before use, see “Install Vessel in PBS-3 SUS” on page 77.

Drip Tray

Confirm that a drip collection container is properly connected to the drip collection line, to catch liquid in the event of spills.

Safety-Related Settings

Confirm that all settings in the “Safety” group match those listed in Appendix 1 on page 196, or that the values have been confirmed with PBS Biotech Technical Support. Do not attempt to verify the functionality of any interlocks - that should only be performed by a representative of PBS Biotech.

Preventative Maintenance

To keep your PBS-3 SUS properly maintained, clean and decontaminate it after each run (see below). For other maintenance on the PBS-3 SUS, contact PBS Biotech Technical Support.

Cleaning and Decontamination

To clean and decontaminate the PBS-3 SUS, use 70% IPA or EtOH. Apply the cleaning solution to a clean, soft cloth - do not spray or apply cleaning solution directly onto the PBS-3 SUS. Wipe down all surfaces of the PBS-3 SUS, including inside the vessel sleeve and drip collection tray. Be very gentle when cleaning the temperature sensor and level sensor. If a leak occurred, flush the

drip collection line and decontaminate or replace the contaminated components of the liquid containment system it leads to. Contact the manufacturers of other equipment in use, such as a keyboard or Uninterruptible Power Supply (UPS), for cleaning and decontamination instructions.

NOTICE Do not use abrasive materials on the PBS-3 SUS. It is the user's responsibility to avoid use of decontamination or cleaning agents that could cause a hazard as a result of a reaction with parts of the equipment or material contained in it. Contact PBS Biotech Technical Support if there is any doubt about the compatibility of decontamination or cleaning agents.

This protocol is appropriate to clean and decontaminate equipment in contact with materials assigned to Biosafety Level 1. In case of operation in a higher Biosafety Level facility, please contact PBS Biotech Technical Support.

Lifting and Handling

The PBS-3 SUS weighs approximately 40 kg (88 lbs). To prevent injury or damage to the product, it should only be lifted by two individuals from the pallet onto the bench. Proper lifting technique of bending at the knees and lifting with the legs should be used. Do not move the PBS-3 SUS by its sleeve as this will cause damage to the load cell.

Note: These specifications are for the standard PBS-3 SUS configuration as of publication. Individual bioreactors may differ.

PBS-3 SUS Specifications		
General	Size	Width: 38 cm (15.0 inches) Depth: 48 cm (18.5 inches) Height: 67 cm (26.5 inches)
	Weight	40 kg (88 lbs) without Vessel
	Minimum Space Requirements	Width: 51 cm (20 inches) Depth: 57 cm (22.5 inches) Height: 92 cm (36 inches)
	Electrical	2.5 A (max), 110-120 Vac, 50/60 Hz or 1.5 A (max), 200-240 Vac, 50/60 Hz, depending on model Overvoltage Category II
	Environmental Rating	Indoor use, Ambient Temperature: 16 - 32 °C (61 - 90 °F) Humidity: 10 - 80% RH Altitude: 2,000 m (6,500 ft) max Pollution Degree: 2
Bioreactor Geometry	Rated Working Volume	3.0 L
	Minimum Working Volume	1.8 L (top of wheel)
	Impeller Type	Vertical-Wheel [®] mixing technology
Controls	Control Interface	Integrated 8.4" touch screen. Network connectivity capability.
	Control Hardware/Software	Industrial embedded real-time control

PBS-3 SUS Specifications		
Controls (continued)	Data Communication	Built-in data historian Standard configuration: remote monitoring via REST API Optional upgrade: remote monitoring and control via OPC-UA
	Data Connection Ports	1x USB 2.0 1x RJ45 Ethernet
Agitation	Agitation Mechanism	Brushless DC motor drive, Magnetic coupling to vessel impeller
	Agitation Control Range (Accuracy)	10 – 50 RPM (± 1 RPM)
	Agitation Sensor Type	Hall effect (magnetic sensing)
Gassing	Gassing Mode	Headspace overlay with an optional sparger
	Gas Control	4 mass flow controllers (for Air, N ₂ , O ₂ , CO ₂ gases) Manual control of total gas flow rate Individual gas outputs as determined by Dissolved Oxygen and pH controls
	Gas Flow Rate Range	30 – 500 mL/min for Air, N ₂ , O ₂ 30 – 100 mL/min for CO ₂
Temperature	Temperature Control Range (Accuracy)	5 °C above ambient to 40 °C (± 0.5 °C)
	Temperature Sensor Type	Class A Platinum RTD
Dissolved Oxygen	DO Control	Two-sided PID control with N ₂ and O ₂ or manual control
	DO Sensor Type	Single-Use Hamilton VisiFerm® fluorometric

PBS-3 SUS Specifications		
pH	pH Control	Two-sided PID control with CO ₂ and base addition pump or manual control
	pH Sensor Type	Single-Use Hamilton OneFerm [®] electrochemical
Level	Level Sensor Type	Load cell
Pumps	Media pump	Watson Marlow 114DV Series Unidirectional, Single-Speed, 200 RPM
	Addition pump A	Watson Marlow 114DV Series Unidirectional, 3-Speed, 200 RPM max. continuous speed
	Addition pump B	Watson Marlow 114DV Series Unidirectional, 3-Speed, 200 RPM max. continuous speed
	Sample	Watson Marlow 114DV Series Bidirectional, Single-Speed, 100 RPM
Single-Use Vessel	Vessel Construction	Injection-molded polycarbonate
	Impeller Construction	Injection-molded polycarbonate
	Product Contact Materials	All product contact materials meet requirements for USP Class VI Testing for Plastics <88> and/or ISO 10993
	Gamma Radiation Absorbed Dose	25 – 40 kGy
	Media, Addition, and Aspiration Lines	Platinum-cured silicone/C-Flex [®] with female luer fitting and cap
	Exhaust Line	Platinum-cured silicone tubing with condenser bag and 0.2-micron exhaust filter

PBS-3 SUS Specifications		
Single-Use Vessel (continued)	Air/CO ₂ /N ₂ Line	Platinum-cured silicone tubing with 0.2-micron filter
	O ₂ Overlay/O ₂ Sparge Lines	Platinum-cured silicone tubing with 0.2-micron filter
	Sampling Line	Platinum-cured silicone and C-Flex [®] tubing with syringe, 3-way valve and 0.2-micron filter
	Harvest Line	Platinum-cured silicone and C-Flex [®] with female luer fitting and cap
Service Life	Mechanical Drive Belt	Expected Service Life 1 year minimum
	Mechanical Drive Components (excepting belt)	Expected Service Life 3 year minimum
Safety and Regulatory	Markings (housing)	NRTL (NEMKO), CE

VisiFerm[®] and OneFerm[®] are owned and/or registered by Hamilton Company in the U.S. and/or other countries.

C-FLEX[®] is a registered trademark of Saint-Gobain Performance Plastics Corporation.

This chapter gives detailed instructions on how to install the PBS-3 SUS.

Integrated Bioreactor

Minimum Space Requirements

Before you begin, see “Minimum Space Requirements” on page 35 and confirm that your available bench space meets or exceeds the minimum space requirements listed.

Utility Requirements

General Electrical Requirements

- Outlets must be properly grounded.
- The power cord must be provided by PBS Biotech, Inc.

For other electrical requirements, see “Electrical” on page 35, and the Safety information in Chapter 3 starting on page 31.

General Gas Requirements

- The gases supplied must be clean, dry, particulate-free, and oil-free to prevent MFC damage from contaminated gases.
- All gases must be connected to their corresponding gas connector inlets on the gas connection panel unless instructed otherwise by PBS Biotech Technical Support.

Gas Tubing Outer Diameter

Depending on the bioreactor’s configuration, it will require one of the following tubing sizes for all gases:

- 1/4 inch OD tubing
- 6 mm OD tubing

Gas Tubing Material

The following materials (or equivalent) are appropriate for the gas tubing:

- Polyethylene
- Polyurethane

NOTICE The gas connectors on the back of the bioreactor are push-to-connect connectors. Disconnecting the tubing requires pushing in the orange or gray connector, then pulling out the tubing. Improper removal of tubing can break the retaining clip and impact the holding capability/seal when tubing is reinstalled.

Gas Supply Pressures

Note: To ensure proper operation, gases must be regulated near the bioreactor system to a consistent pressure within the ranges specified below. Fluctuating inlet gas pressure may cause MFC flow rates to become unstable.

Gas	Imperial	Metric
Air, O ₂ , N ₂	20 – 40 psig	140 – 275 kPa
CO ₂	14 – 16 psig	96.5 – 110 kPa

Unit Placement

To prevent bodily injury and/or damage to the product, see “Lifting and Handling” on page 34 and follow the safety instructions.

The unit should be placed on a tabletop or benchtop where the appropriate utilities have been prepared.

Once the unit is in place, the utilities and liquid containment system may be connected.

Connecting the Drip Collection Line

The drip collection line is located behind the bioreactor. It must be attached to tubing with an internal diameter of 1.27 cm (0.50 in). The tubing should lead to a container below the bioreactor to allow overflow from the vessel to drain through the line by gravity.

Powering On the PBS-3 SUS

Install the appropriate power cord on the PBS-3 SUS. It is recommended to plug it into an Uninterruptible Power Supply (UPS), to allow control to be

maintained in the event of a power failure. A grounded outlet is required. The PBS-3 SUS will automatically power on, and the Hello UI will automatically load once the system has finished booting.

Configuring Local Users and Groups

The Hello UI requires a user to log in before making any changes. This section describes how to create new local users and modify local user accounts.

The bioreactor can also be configured so users can log in to the bioreactor with domain credentials. When the Domain login option is enabled, users can still log in using local user accounts; this is useful for maintenance accounts, local administration, and fallback during network issues. For IT instructions to enable the Domain login option on the bioreactor and configure the domain, see “Configuring Domain Login” on page 167.

The PBS-3 SUS comes with two default local user accounts for you to start with:

Username: user1
Password: 12345
Permissions: All but “Account Management”

Username: admin
Password: 12345
Permissions: None but “Account Management”

The PBS-3 SUS also comes with a local user account “pbstech,” which will be used by PBS Biotech Technical Support if they need to log in to your bioreactor system. This is the only account in the “pbstech” user group. Do not delete or change this account or user group, and do not add other users to the user group.

PBS Biotech Technical Support strongly suggests changing the username and password for the user1 and admin accounts to make them more secure, and adding accounts with unique usernames and passwords for each individual accessing the bioreactor system.

While all usernames and passwords should be as secure as possible, it is particularly important to change the admin account username and password to something that is difficult to guess in order to prevent malicious users from accessing that account to give themselves extra permissions they are not authorized to have.

In order to prevent users from being permanently locked out of their bioreactor, the PBS Software prohibits password expiration for user groups with the Account Management permission, and users within these user groups (i.e.

Account Managers) cannot be locked out after multiple failed login attempts. For security purposes, the usernames associated with these user groups should remain unknown to all other users. The software requires that at least one local Account Manager account remains Active. Local Account Manager accounts cannot delete or disable their own account, change their own group, or remove their own group's account management permission. Domain logins with the Account Management permission cannot delete or disable the last Active local Account Manager. Domain Account Managers cannot change the last local Account Manager's group assignment or remove the Account Management permission from a group in a way that results in there being no local Account Managers. And, if no local Account Managers exist when the application starts, the Domain login option will be enabled automatically.

Creating a New Local User Group

1. Log in to the Hello UI using the user name and password of an account in a group with the "Account Management" permission.
2. Click the triple bar ≡ (top right corner) and then "Administration."

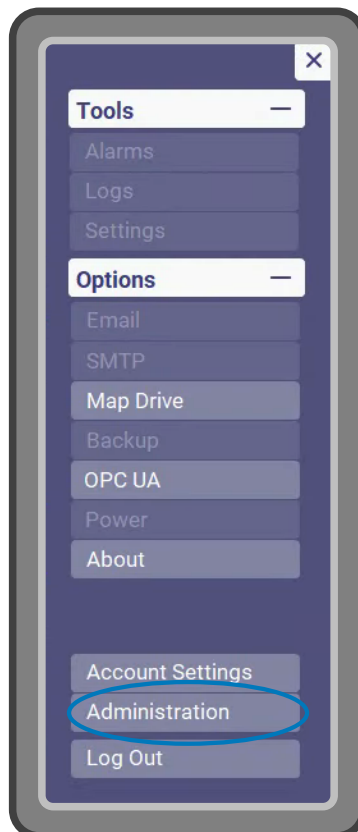

3. Navigate to the “Configure Groups” tab.



4. Click “Add Group” and enter a name using the on-screen keyboard or an external keyboard. Groups with blank names cannot be saved. Click “Enter.”

Editing Local Group Permissions

Group permissions are divided into four categories: Operation, Process Configuration, Advanced Configuration, and Administration. To edit the permissions of a group, select the group from the Group List, and click the button of the permission. Bright green indicates that the permission is granted, gray indicates that the user group does not have that permission. For more information on group permissions, see “User Group Permissions” on page 161.



Editing Local Group Password Settings

1. To edit the password settings, click the “Password Settings” button.

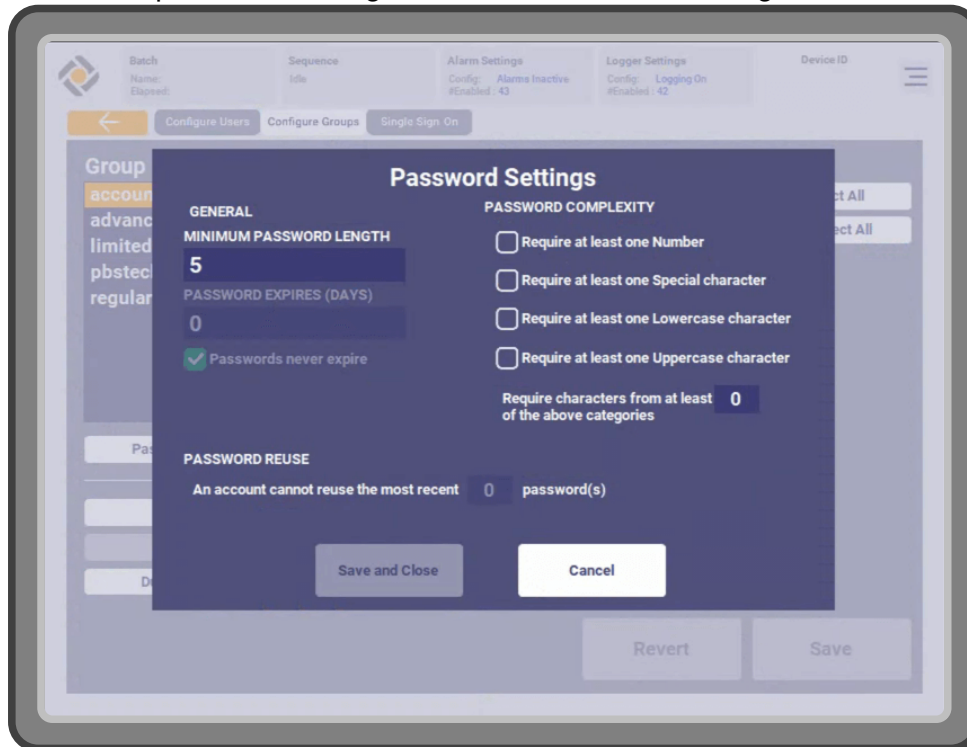

2. New groups have the following default password settings:
 - (a) A minimum password length of 5
 - (b) Passwords never expire
 - (c) There are no limits on password reuse
 - (d) Simplest password complexity: there is no requirement to use numbers, special characters, lowercase characters, or uppercase characters.

Creating a New Local User

1. Navigate to the “Configure Users” tab.

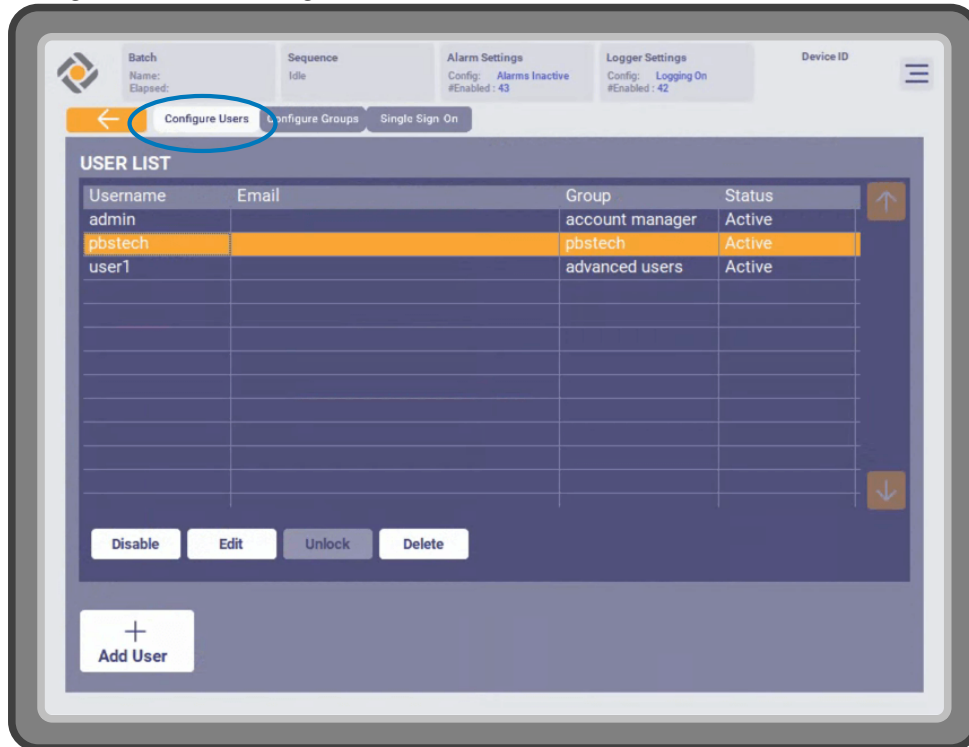

2. Click “Add User,” and the “Add User” screen will appear.

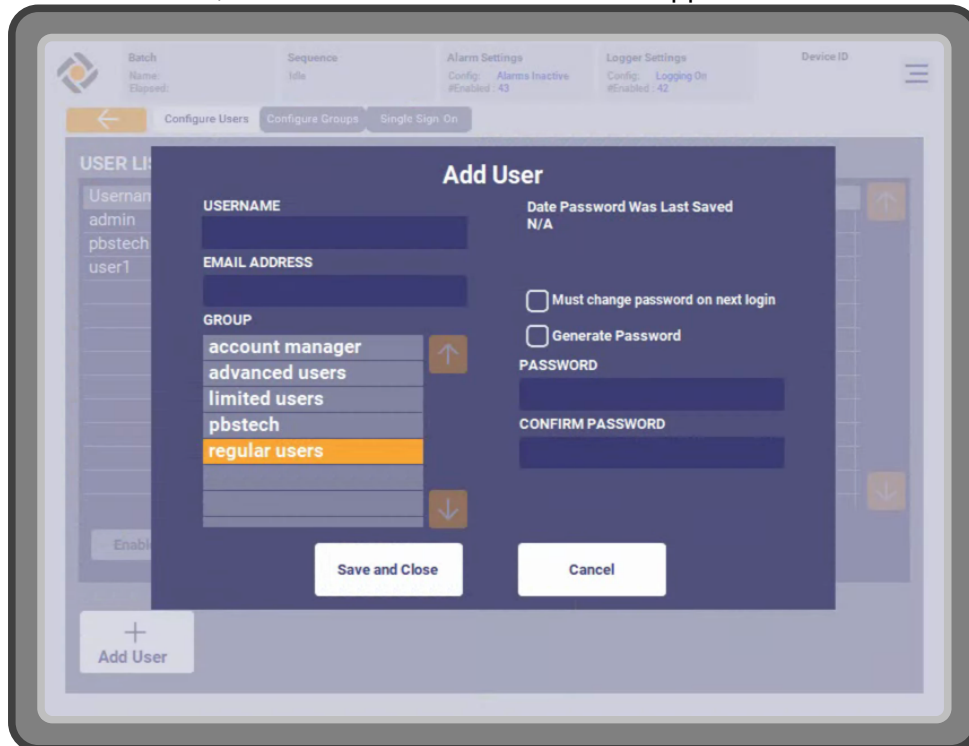

3. To change the name, click the text field under “Username” and use the

on-screen keyboard or an external keyboard to enter a new name, then click “Enter.” Usernames must be unique, cannot be blank, and cannot contain spaces.

4. (Optional) To link an email address to the user, click the “Email Address” field and enter a valid email address. The account’s email address is used to send alerts about failed login attempts and to simplify emailing reports.
5. Select the user group that the user will be assigned to from the “Group” list.
6. The account manager can either enter a new password for the user, or check the “Generate Password” box, so the PBS Software will generate a password for the user on saving. Passwords must meet the requirements for the selected group.
7. The account manager can also require that the user change their password the next time they log in.
8. When you are finished, click “Save and Close.”

Modifying Local User Accounts

1. To edit a user, select the user in the “User List” section under the “Configure Users” tab, and then click “Edit.” Change the User Name, Password, Email Address, or Group. Click the “Save and Close” button to save the new user settings.
2. To delete a user, select the user in the “User List” section under the “Configure Users” tab, and click the “Delete” button.
3. To edit a user group, select the group in the “Group List” section under the “Configure Groups” tab. Change the Password Settings or Permission Options. Click the “Save” button to save any changes.
4. To delete a user group, select the group in the “Group List” section under the “Configure Groups” tab, click the “Delete Group” button, and click the “Save” button. Note that groups with users still assigned to them cannot be deleted.

Users' Own Accounts

Local users without the “Account Management” permission can modify their own password (to prevent it from expiring) and their own email address. They will not be able to modify anything else in their account, or see any information about any other user account.

Domain users cannot make changes to their accounts, but they will be able to see which permissions are assigned to them.

1. Click the triple bar ≡ (top right corner) and then “Account Settings.”

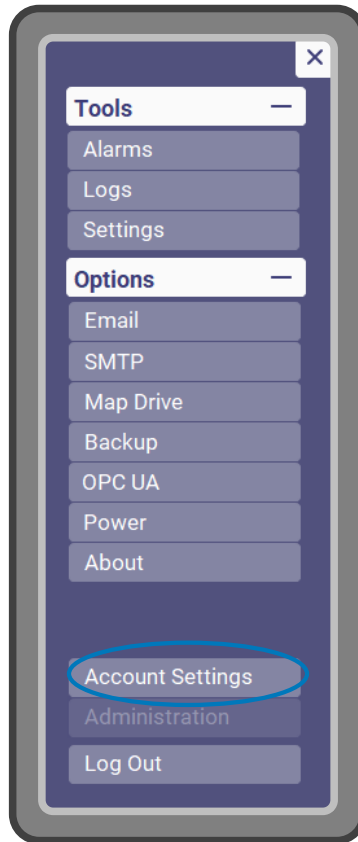

2. For a Local user, make and save desired changes.

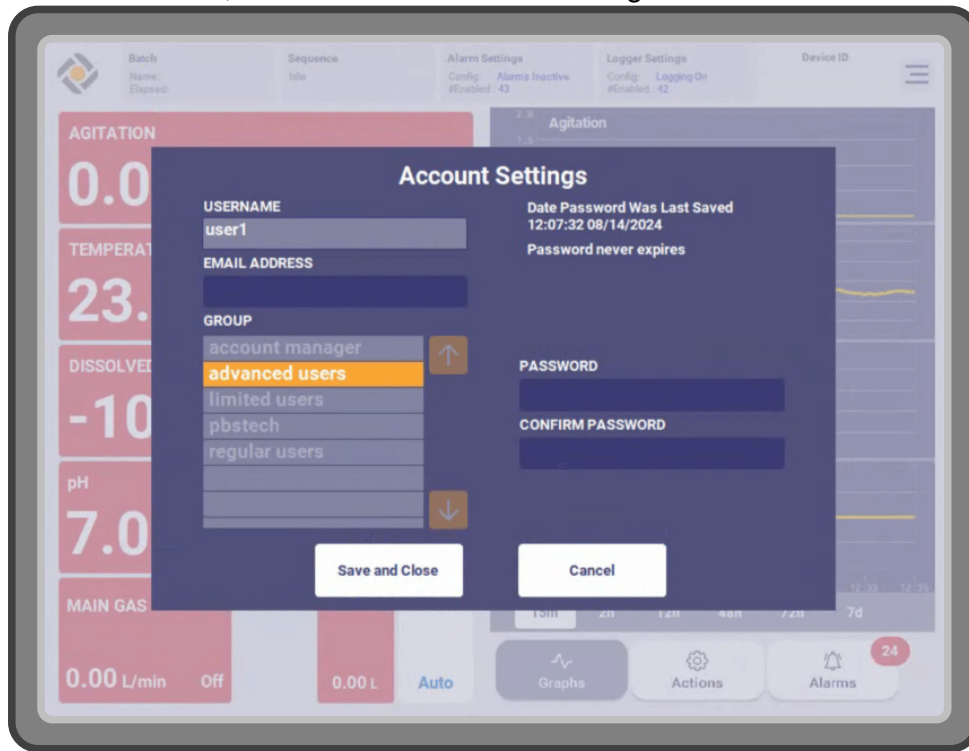

For a Domain user, view the assigned permissions.

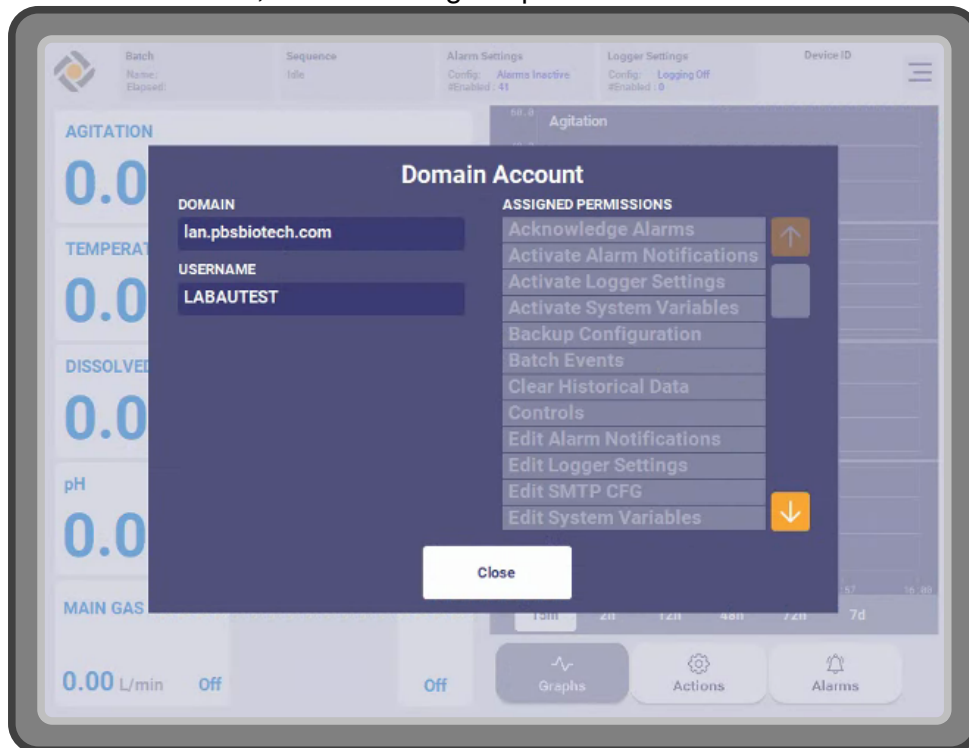

Naming the PBS-3 SUS

The PBS-3 SUS ships with a generic name. However, PBS Biotech Technical Support suggests you change the name as you see fit.

1. Log in to the Hello UI as a user with “System Management” permission.
2. Click the triple bar ≡ (top right corner) and then “About.”

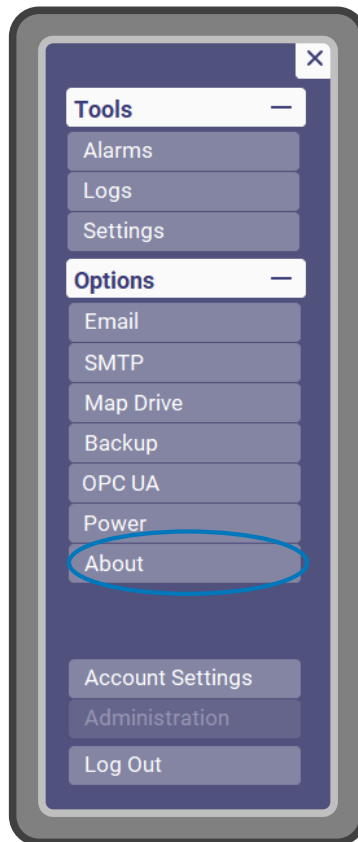

3. Click “Change Display Name.”

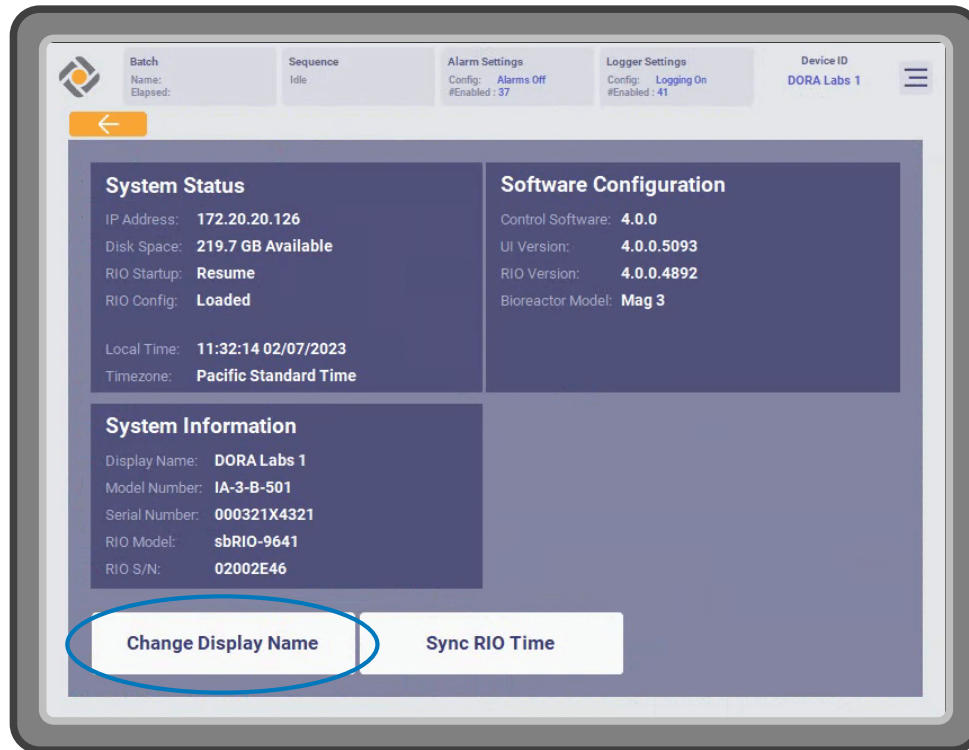

4. Enter the desired name using the on screen keyboard or an external keyboard and select “Enter.”

Configuring Logger Settings

Before beginning a run, you should configure what data is recorded and how often. For an in-depth explanation for how data recording works, see “Process Data Recording” on page 155.

1. Log in to the Hello UI as a user with the “Logger Settings Editor” and “Activate Logger Settings” permissions. The “Logger Settings Editor” permission allows the user to create, modify, and delete Logger Settings files, whereas the “Activate Logger Settings” permission allows the user to make a particular Logger Settings file active.
2. Click the triple bar ≡ (top right corner) and then “Logs.”

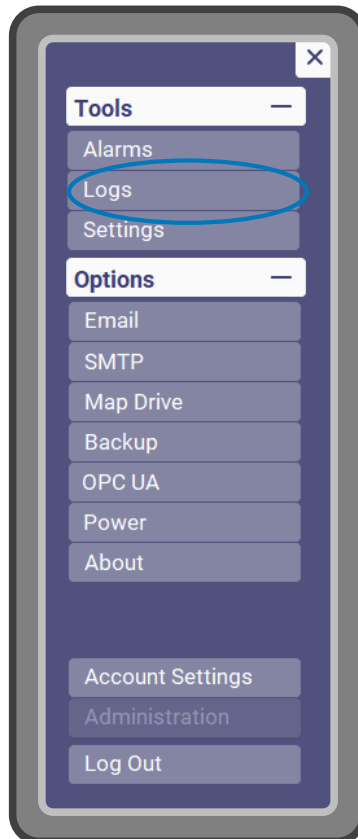

3. Click “New” if you would like to create an entirely new Logger Settings file. Select an existing file to duplicate, delete, rename, or edit it. You cannot delete or rename the active Logger Settings file. You can create multiple logger settings configuration files and give them different names.

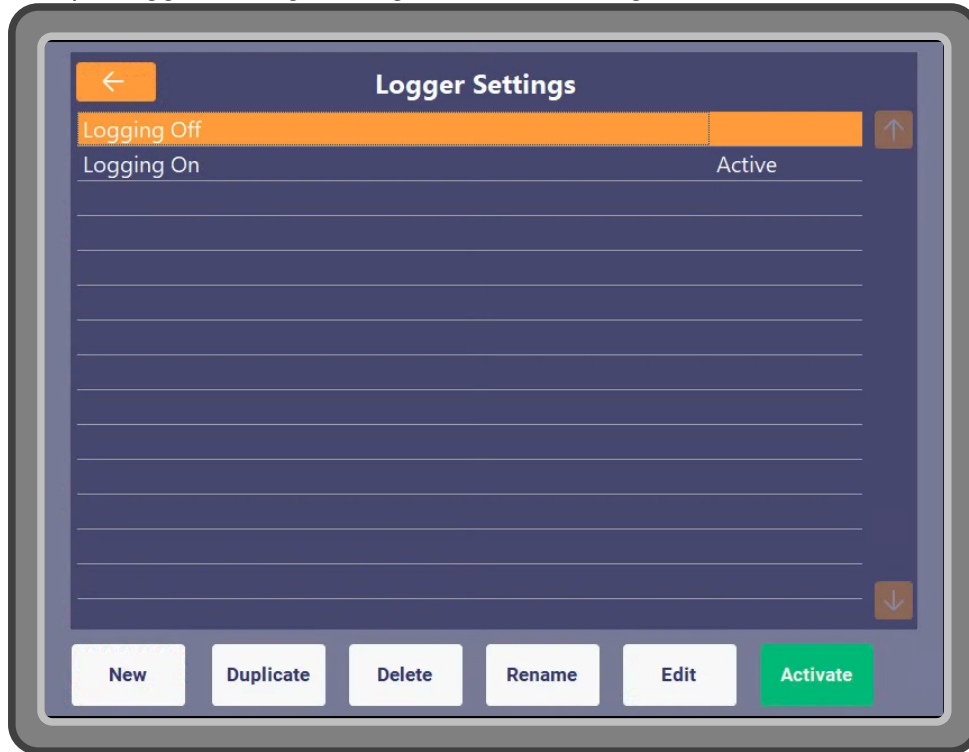

- The screen will display the variable name, a green checkbox, the deadband value, and the group the variable belongs to.

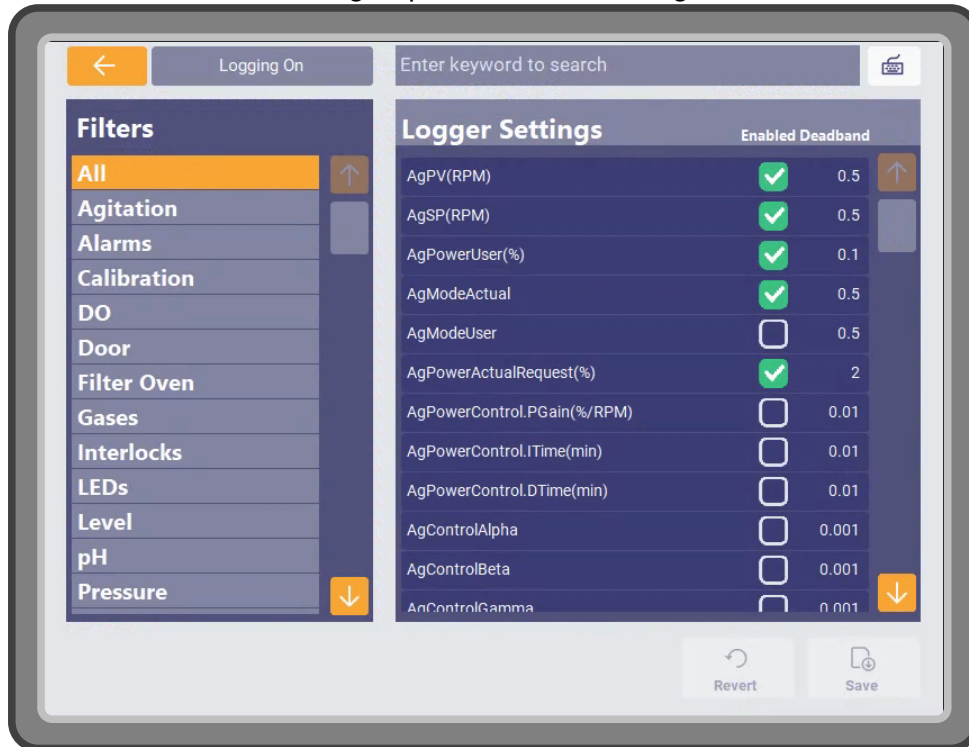

- To change the value of the deadband for a variable, click the number field next to the corresponding variable and enter the desired value using the on-screen keypad or an external keyboard.
- To change whether a variable is recorded or not, click the “Enabled” square. Green with a white checkbox indicates that the variable will be recorded, while an empty box indicates that it will not.
- If you wish to reverse changes you have made, click “Revert” and the file will revert back to its original values.
- When you are finished making your desired changes, click “Save.” Click the arrow in the top left corner to return to the main Logger Settings menu.
- Click “Activate” to make the selected file active on the RIO. The active Logger file name and number of enabled parameters will be displayed in the Information Bar.

Configuring Alarm Settings

The PBS-3 SUS comes with its Alarms Inactive file loaded so the non-run conditions will not set off any alarms (disconnected sensors, temperature far below 37 °C, etc.). You can create and edit multiple Alarms configuration files using the Alarms Editor in the Hello UI.

Creating and Editing Alarm Files

1. Log in to the Hello UI as a user with the “Alarm Settings Editor” and “Activate Alarm Settings” permissions. The “Alarm Settings Editor” permission allows the user to create, modify, and delete Alarm Settings files, whereas the “Activate Alarm Settings” permission allows the user to make a particular Alarm Settings file active.
2. Click the triple bar ≡ (top right corner) and then “Alarms.”

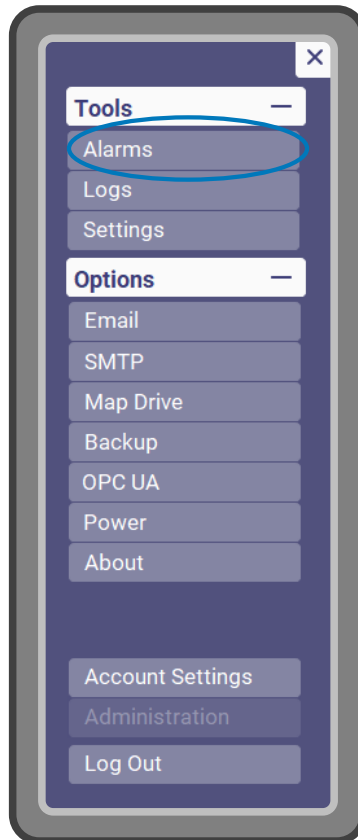

3. Click “New” if you would like to create an entirely new Alarms Settings file. Select an existing file to duplicate, delete, rename, or edit it. You cannot delete or rename the active Alarms Settings file. You can create multiple alarms settings configuration files and give them different names.

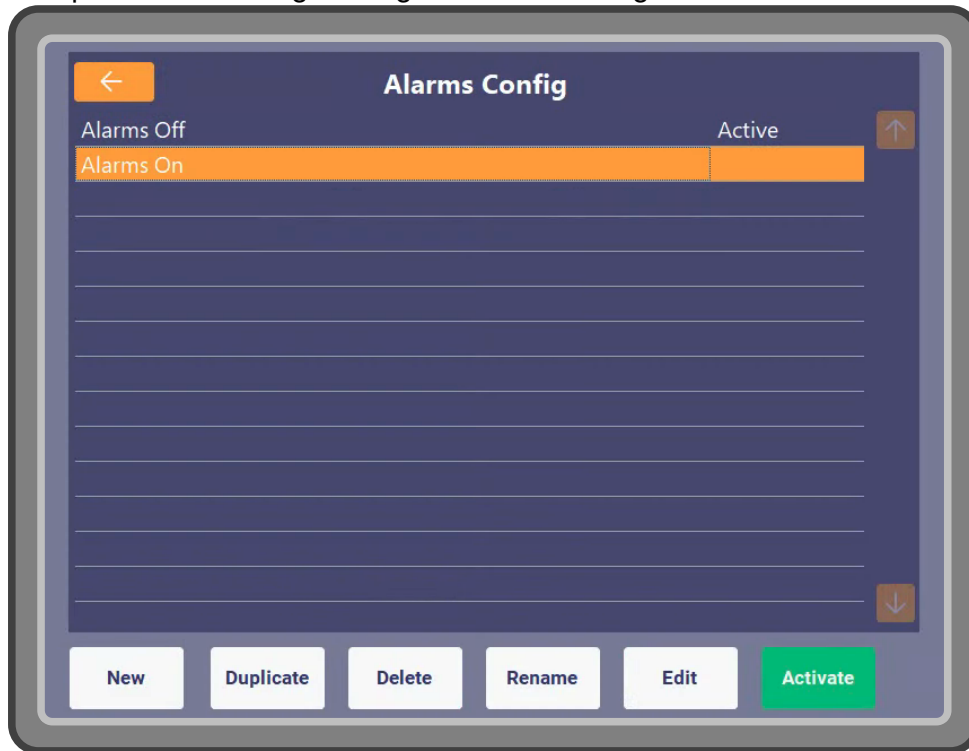

- Configure alarms notifications by selecting “Notify,” “Audible,” and/or “Email” for each alarm, where “Notify” means the alarm appears in the Alarms tab of the Hello UI when the alarm is triggered, “Audible” means a buzzer sounds when the alarm is triggered, and “Email” means an email is sent to all of the email addresses in the “Email List” from the email address in the “Return Address” field (see “Configuring Email Function” on page 57). Note that for an alarm to be emailed or audible, it must also be set to “Notify.”



- If you wish to reverse changes you have made, click “Revert” and the file will revert back to its original values.
- When you are finished making your desired changes, click “Save.” Click the arrow in the top left corner to return to the main Alarm Settings menu.
- Click “Activate” to make the selected file active on the RIO. The active Alarms file name and number of enabled alarms will be displayed in the Information Bar.

Configuring Email Function

The PBS-3 SUS arrives with a PBS Biotech email address for sending emails. The size limit for generating and emailing files is 35 MB using the default office365 account configured at factory.

Configuring Sending Email

1. Log in to the Hello UI as a user with the “Email Settings” permission.
2. Click the triple bar ≡ (top right corner) and then “SMTP:”

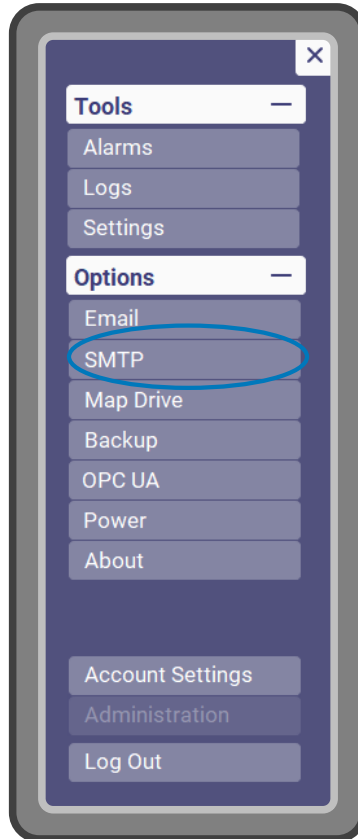

3. Configure the SMTP Settings as desired.

The screenshot shows the 'SMTP Settings' configuration interface. It includes the following fields and controls:

- Sender Address:** pbs@pbscustomer.com
- Password:** Masked with asterisks (*****)
- Server:** smtp.office365.com
- Port:** 587
- Enable SSL:** Checked (indicated by a green checkmark)
- Buttons:** 'Send Test Email', 'Revert', and 'Save'.

4. Click “Send Test Email” and enter a valid email address as the recipient, to verify that the email settings are configured correctly.
5. If you wish to reverse changes you have made, click “Revert” and the settings will revert back to their original values.
6. When you are finished making your desired changes, click “Save.” Click the arrow in the top left corner to return to the main menu.

Configuring Alarms Email List

When an alarm configured to be emailed is triggered, the email addresses on this list will receive an email. If more than one alarm of the same type is triggered within the “Alarm Email Snooze Time,” only the first alarm triggered will be emailed.

1. Log in to the Hello UI as a user with the “Email Settings” permission.

2. Click the triple bar ≡ (top right corner) and then “Email.”

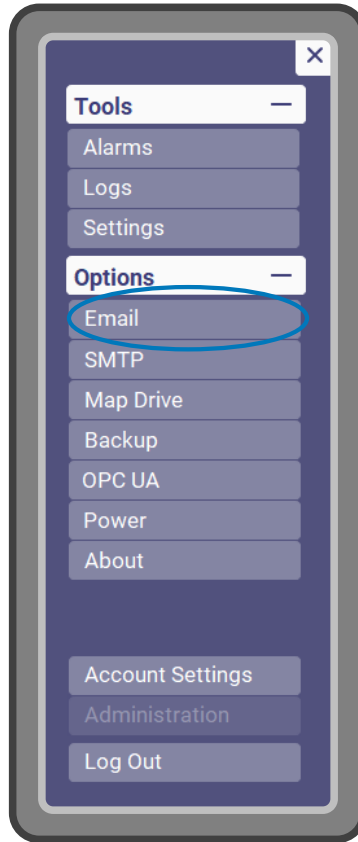

3. Click “Add” to add a new email address to the list. Select an existing email address to delete it, or to send a test email to it.

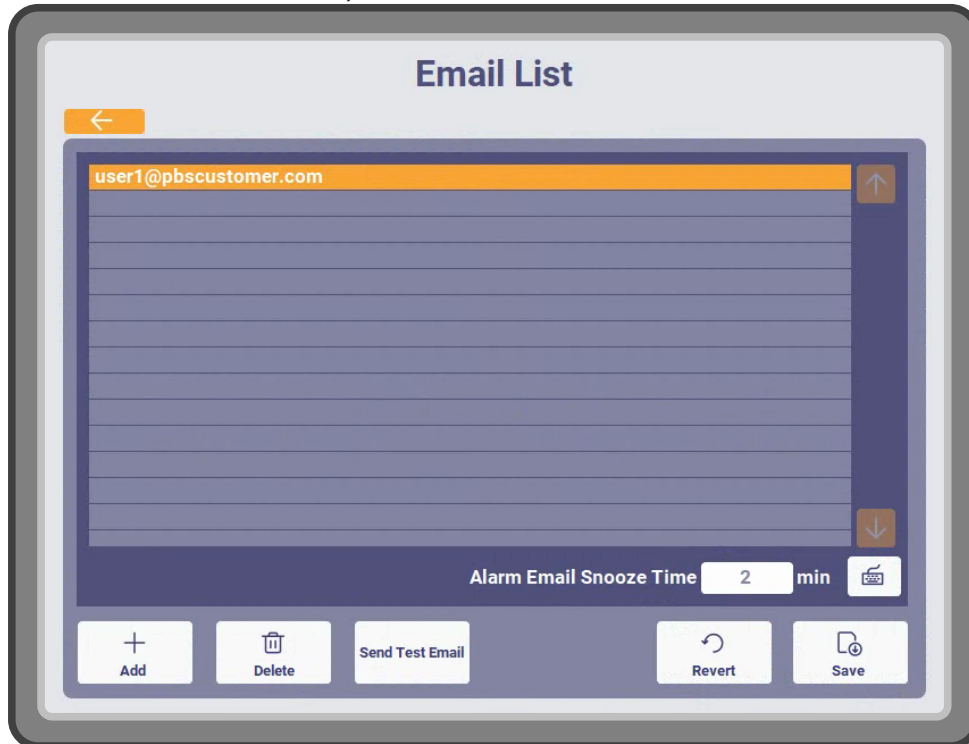

NOTICE You can get alarm notifications as text messages. PBS Biotech Technical Support suggests researching SMS gateways to learn which email address to use for your phone number, or contacting your IT department for assistance.

4. To change the “Alarm Email Snooze Time,” click the number and use an external keyboard or use the on-screen keyboard.
5. If you wish to reverse changes you have made, click “Revert” and the file will revert back to its original values.
6. When you are finished making your desired changes, click “Save.” Click the arrow in the top left corner to return to the main menu.

Configuring Automatic Backups

The PBS-3 SUS can automatically back up either just the Historical Records database, or the Historical Records database along with the User Configurations database and all the configuration files and reports.

NOTICE Users are responsible for their own backup and recovery.

Mapping Network Drives for Automatic Backup

1. Log in to the Hello UI with a user account with the “Backup Configuration” permission.
2. Click the triple bar ≡ (top right corner) and then “Map Drive.”

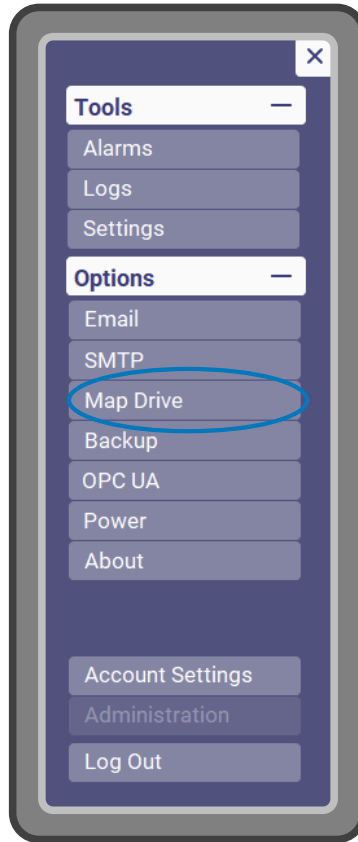

- Click “Add” to map a new network location.

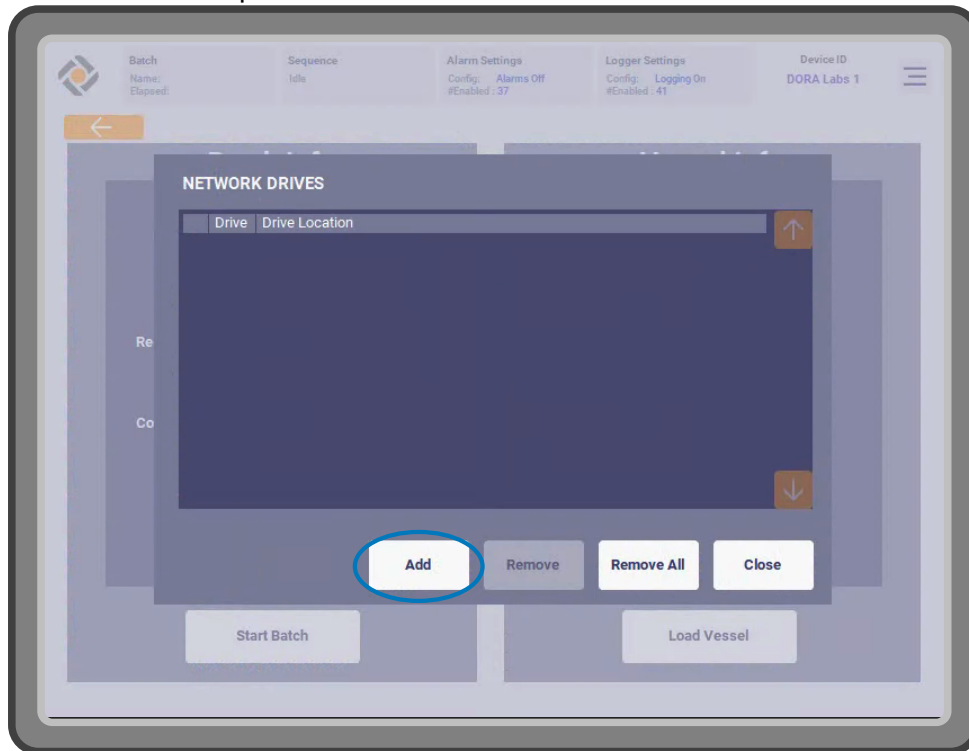

- Input the Path, assign a Drive Letter, and input the Username and Password (if required). Then click “Add” to save.

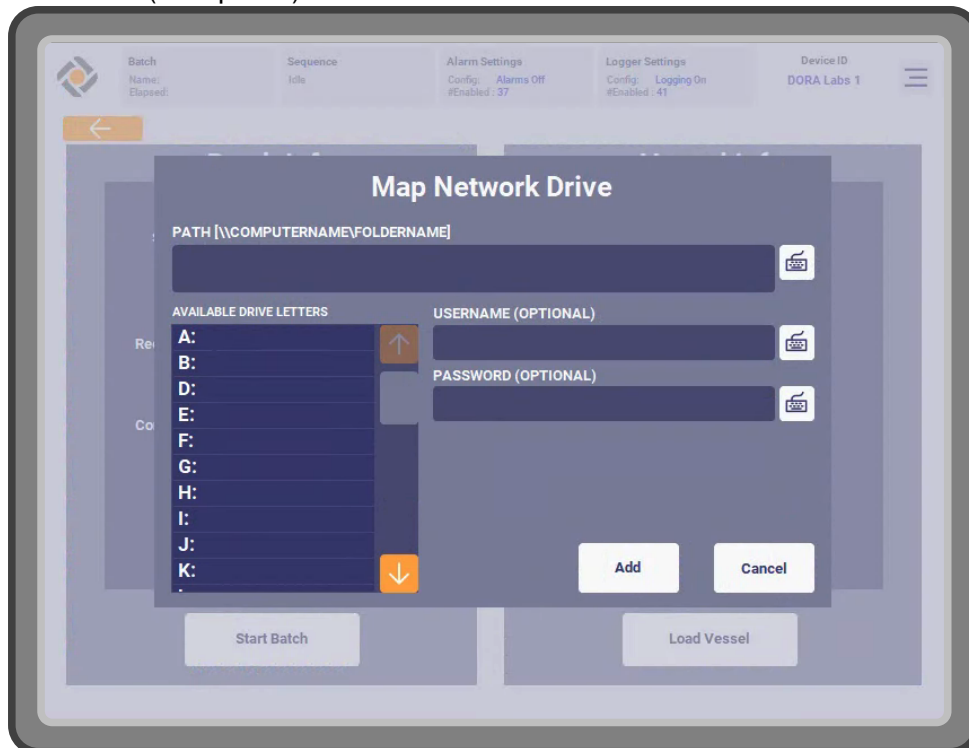

- Click the “Close” button to return to the main menu.

Scheduling Automatic Backups

1. Log in to the Hello UI with a user account with the “Backup Configuration” permission.
2. Click the triple bar ≡ (top right corner) and then “Backup.”

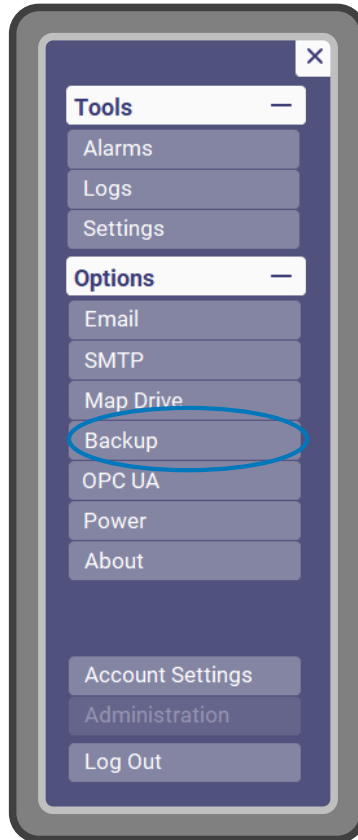

3. Click “Add” to create a new scheduled backup. Select an existing scheduled backup to edit or delete it.

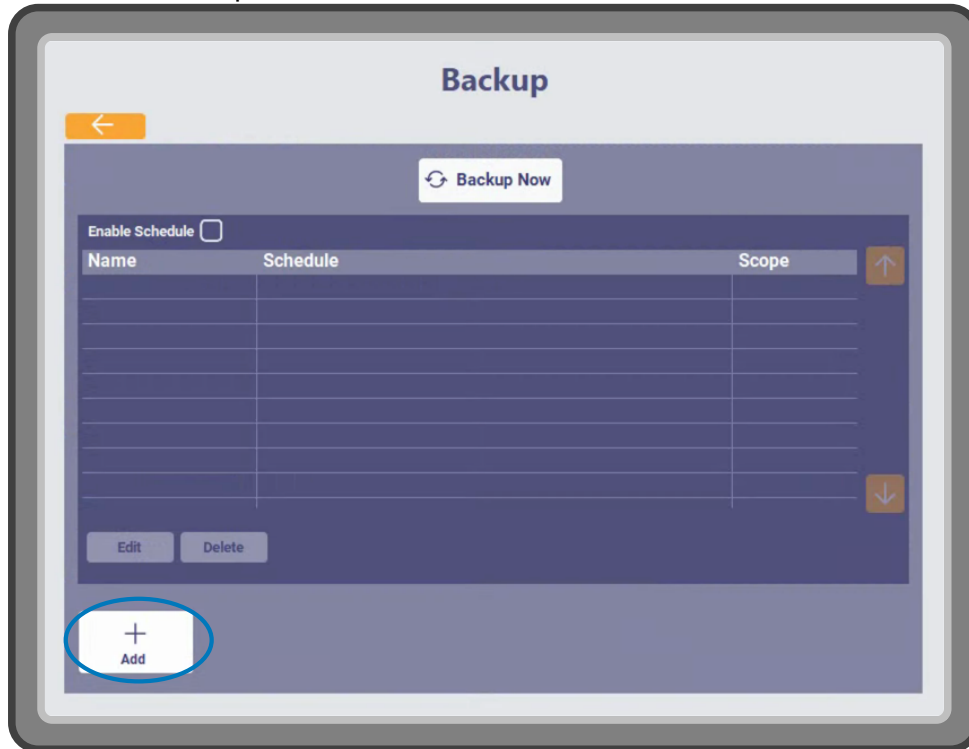

4. Configure the scheduled backup.

- (a) Name - this must be unique. The backup file name will start with this, and have a date and time at the end, in form name_YYYY-MM-DD_hh-mm-ss
- (b) Destination - this can be a mapped network drive (see “Mapping Network Drives for Automatic Backup” on page 62) or a physical drive attached via USB.
- (c) Recurrence - Frequency of backup. If “Hours” is selected, the number of minutes past the hour can be specified, to avoid having multiple bioreactors all performing their backup at the same time and overloading the network. If “Days” is selected, then a specific time for the backup is set. The “Next Backup” field updates based on how Recurrence is configured.
- (d) Scope - “DB Export” backs up the Historical Records database. “Full” backs up the Historical Records database along with the User Configurations database and all the configuration files and reports.

5. Click “Save” to save the scheduled backup.

6. Click the arrow in the top left corner to return to the main menu.

Note: The automatic backup function can be disabled by un-checking the “Enable Schedule” checkbox in the Backup menu.

Note: Backups can also be performed manually from the Backup menu by

clicking “Backup Now” and setting the Name, Destination, and Scope.

Congratulations! You have now set up your PBS-3 SUS and configured user accounts, logger settings, and alarms. Please see Chapter 6 for more details to begin using the PBS-3 SUS.

Before You Begin

This chapter will explain how to perform all the steps associated with a typical run, as well as tasks that a user may want to perform at any time from start to finish. Reading the preceding chapters is highly recommended before continuing.

Suggested Order of Operations

Set Up Run

1. Configure dip tube and tubing assembly (if using dip tube)
2. Autoclave dip tube (if using)
3. Confirm gas source pressure matches specifications (see “Utility Requirements” on page 39)
4. Install dip tube in vessel (if using)
5. HMI Computer Restart
6. Load Vessel
7. Install vessel in PBS-3 SUS
8. Level ‘Zero’ calibration
9. Add medium
10. Level ‘Span’ calibration (if necessary)
11. Control temperature, agitation, and main gas as for process. Control DO and pH in Manual mode.
12. Wait for equilibration
13. ‘Span’ DO calibration
14. ‘One-point’ pH calibration
15. Control DO and pH in Auto mode
16. Load the Alarms On.alm file
17. Add cells
18. Start batch

During Run

1. Take Sample
2. Perform Medium feed/exchange (if applicable)

End Run

1. Load the Alarms Inactive.alm file
2. Harvest
3. End batch
4. Clean/decontaminate the PBS-3 SUS

Before Starting a Batch Run

Configure Optional Dip Tube and Tubing Assembly

The dip tube can be used in addition to or in place of the aspiration lines (e.g. if the locations of the aspiration lines are not desirable).

The dip tube can be used for the following purposes, among others:

- To remove spent medium, without removing settled cells
- To add liquids to the vessel, to minimize splashing
- To take a representative sample

The inner diameter of the tubing directly attached to the dip tube should be 3/16 inches. The dip tube itself should be configured so the maximum length of the dip tube extends into the vessel, beneath the compression fitting. After autoclaving, when it is installed in the vessel, the distance the dip tube extends into the vessel can be set.

All tubing branches should have clamps so the flow of liquid is controlled.

If the dip tube is being used for taking samples, it is recommended to separately prepare a small transfer flask with a short dip tube (see “Take Sample” on page 100), and connect it to the dip tube after the dip tube has been installed in the vessel.

If the dip tube is being used for taking samples of microcarrier culture or cell aggregates, it is best if the tubing and all connections are 3/16 inch inner diameter or larger. Tubing that is 1/4 inch inner diameter can be used instead, except for the connection directly to the dip tube. A reducer from 1/4 inch to 3/16 inch can be used to connect the tubing to the dip tube, or the 3/16 inch tubing can be stretched to fit over hose barbs meant for 1/4 inch inner diameter tubing. When preparing to autoclave, the tubing line(s) should not be plugged or clamped, so steam can fully penetrate the tubing.

Autoclaving Optional Dip Tube

1. Clean the dip tube, being sure to rinse with DI water.
2. Place the dip tube in an autoclave pouch, such that the nonsterile portion is easiest to access when the pouch is opened in the biosafety cabinet.
3. Seal the pouch.
4. Place the dip tube in the autoclave.
5. Autoclave per Standard Operating Procedure of your bioprocessing facility, using either slow exhaust or liquid cycle. The temperature should be 121 °C for at least 30 minutes.

Install Optional Dip Tube

CAUTION! Wait until the dip tube is cool to the touch before installing in the vessel.

Note: The PBS Wrench can be used to assist in the installation or removal of port caps and accessories, such as the dip tube.

1. Sanitize the autoclave pouch with 70% IPA or equivalent.
2. Transfer the autoclave pouch to biosafety cabinet.
3. Remove vessel outer packaging.
4. Sanitize vessel inner packaging with 70% IPA or equivalent.
5. Transfer packaged vessel into biosafety cabinet.
6. Remove vessel inner packaging.
7. Inspect the vessel and all tubing for damage inflicted during shipping.
8. Install the dip tube as follows:
 - (a) Position the vessel so the port cap is accessible and tubing is not in the way. The dip tube will be installed in the front right port cap (see image below).
 - (b) Loosen the port cap using the PBS Wrench.
 - (c) Remove the dip tube from the autoclave pouch, only touching the nonsterile portion.
 - (d) Remove the port cap.
 - (e) Guide the dip tube through the port.
 - (f) Thread the dip tube tightly into the port.

Note: If the dip tube is being used, PBS Biotech Technical Support recommends installing it after any other accessories, since its tubing can interfere with installing other accessories. Loosen the

compression fitting on the dip tube, screw the dip tube into the vessel, adjust the height, and then tighten the compression fitting. The dip tube can be raised out of the vessel without compromising sterility, but cannot be pushed back down. This can also be done in the middle of a run, as long as the vessel is first placed in the biosafety cabinet. Ensure the angled tip of the dip tube does not interfere with the wheel.

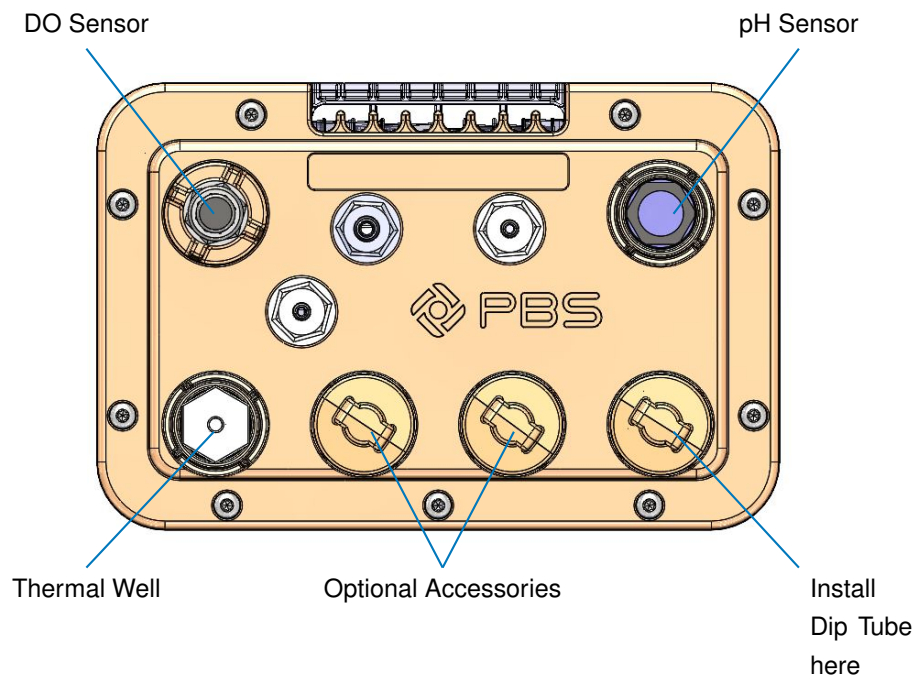

9. Make connections to tubing as necessary. This will likely include connecting the dip tube to a transfer flask, if using.
10. Transfer the vessel out of the biosafety cabinet.

Log In to the Hello UI

Local Login Only (default):

1. Click anywhere to go to the Login menu.



2. Enter your Username and Password with the on-screen keypad, or with an external keyboard.
3. Click “Login.”

Domain Enabled:

Logging in to a Domain account requires the feature to be enabled and configured on the bioreactor, requires the Domain to be configured appropriately, and requires that the Domain account has at least one (1) PBS permission associated with the account. For IT instructions to enable the Domain login option on the bioreactor and configure the domain, see “Configuring Domain Login” on page 167.

Note: Failed Domain login attempts are processed by the Domain controller, and may lock the account out on other systems.

1. Click anywhere to go to the Login menu.



2. For a Domain login, enter your Username and Password with the on-screen keypad, or with an external keyboard.
The Usernames and Passwords for Domain accounts are corporate credentials, assigned and managed by the customers' IT team.
The entered username should not have domain prefix or UNC suffix. For example, the user should enter "johnsmith" and not "EXAMPLE\johnsmith" or "johnsmith@example.com"
3. Click "Login."

Note: The 'Domain' field is automatically populated with the default specified when the bioreactor was configured to use this feature. It can be modified, if different from the default.

Note: To log in to a Local account while the Domain login feature is enabled, click "LOCAL" and enter your Username and Password.

Restarting the HMI Computer

Like any computer, the bioreactor's HMI benefits from occasional reboots. Doing so before starting a run is especially beneficial if the bioreactor has been on for a significant amount of time.

To Restart the HMI with the Hello UI:

1. Click the triple bar ≡ (top right corner) and then "Power."

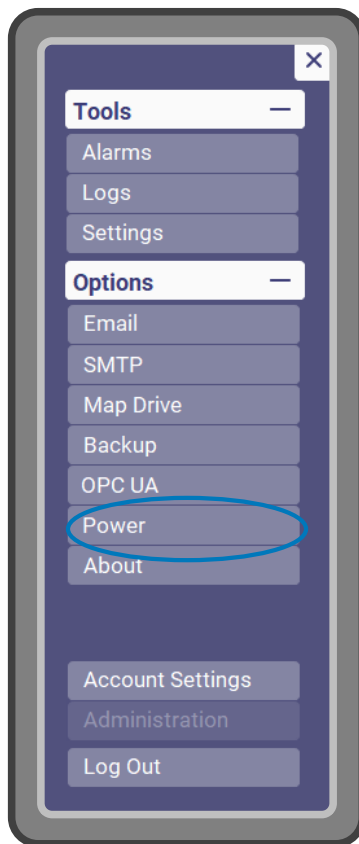

2. Click the “Restart” button under “Windows Actions.”

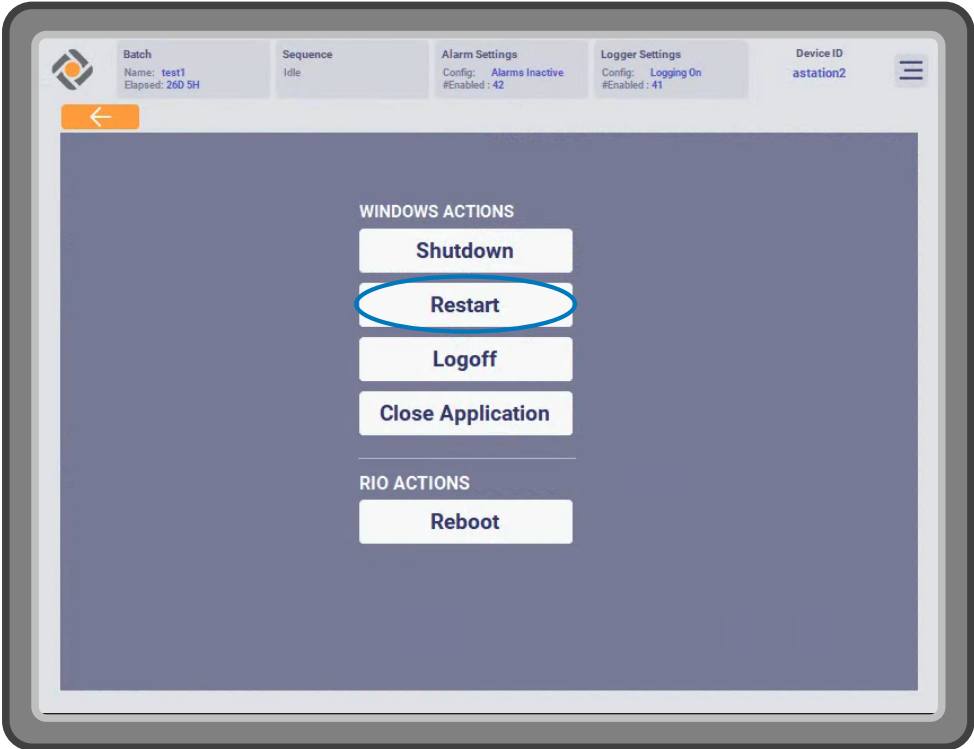

Load Vessel

To load a vessel:

1. Navigate to the “Actions” tab.
2. Click “Batch.”

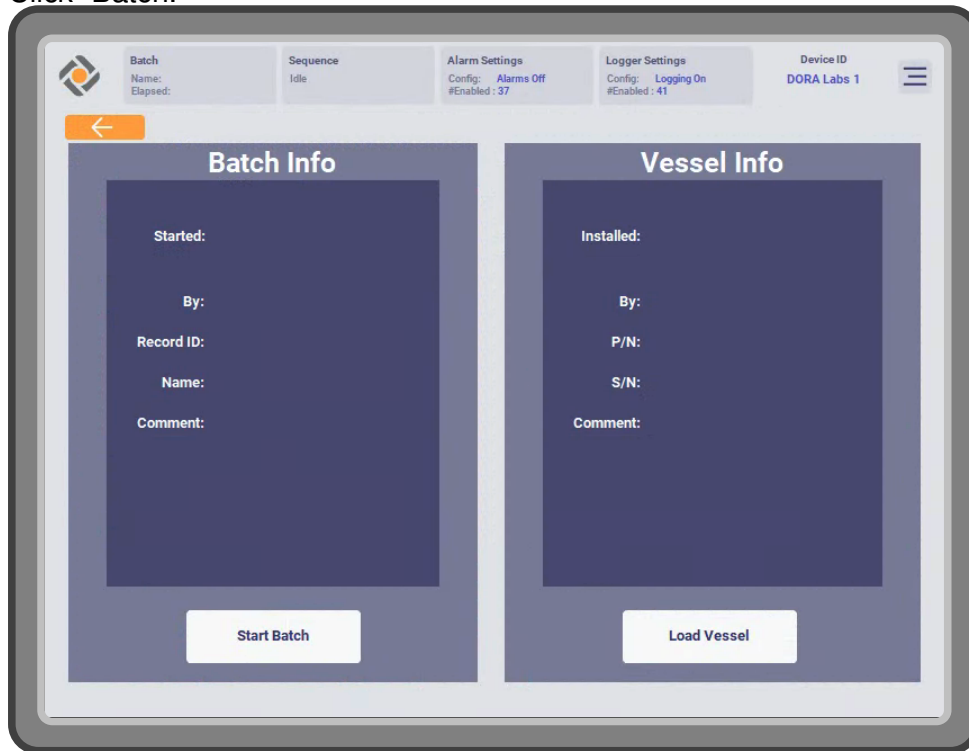

3. Click “Load Vessel.”

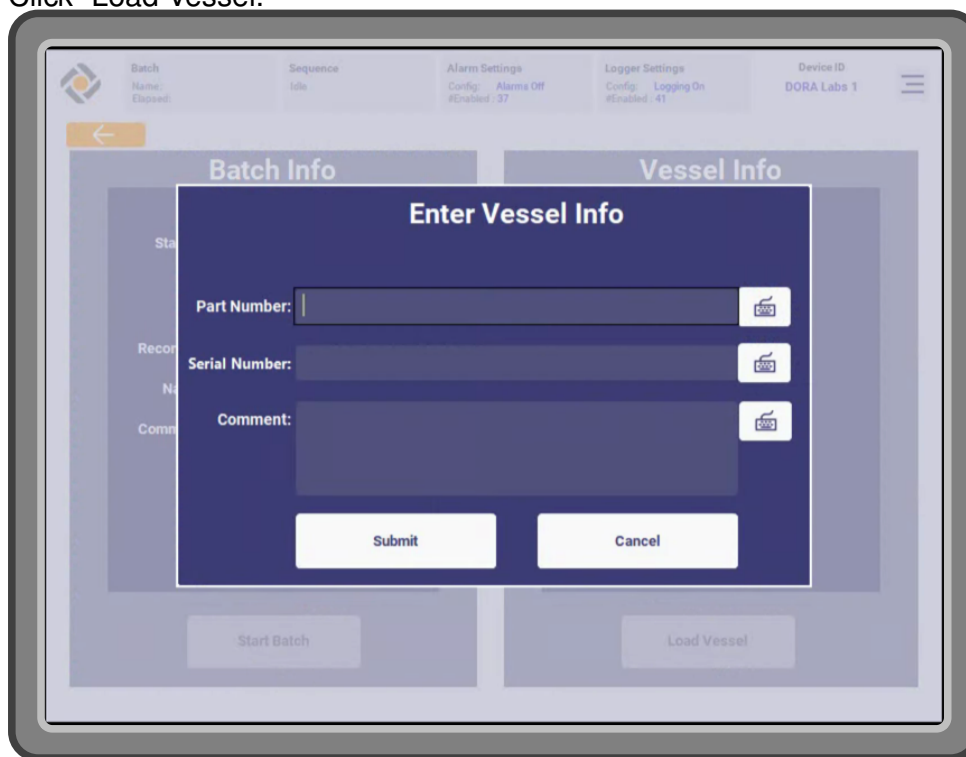

4. Enter the vessel part number.
5. Enter the vessel serial number.
6. Enter a comment, if desired.
7. Click “Submit.”

Install Vessel in PBS-3 SUS

Note: These instructions are for the standard PBS-3 SUS Bioreactor vessel configuration. If your vessel is different, please consult its installation protocol.

1. Connect any optional extensions in a biosafety cabinet.

Note: The PBS Wrench can be used to assist in the installation or removal of port caps and accessories, such as the dip tube.
2. Hang the DO and pH sensor cables outside the vessel sleeve, and check that nothing is in the sleeve.
3. Hold the vessel so the back (i.e. the side with tubing coming out of it) faces away from you.

- Slide the vessel into the sleeve, feet first. Make sure the head of the Tubing management cable slides in to the closest corner of the sleeve, or the vessel will not slide all the way in. The bottom of the vessel should rest against the heaters (Diagram A.), and there should be a gap of approximately 8 mm (5/16 in) between the top of the sleeve and the vessel lid (Diagram B.).

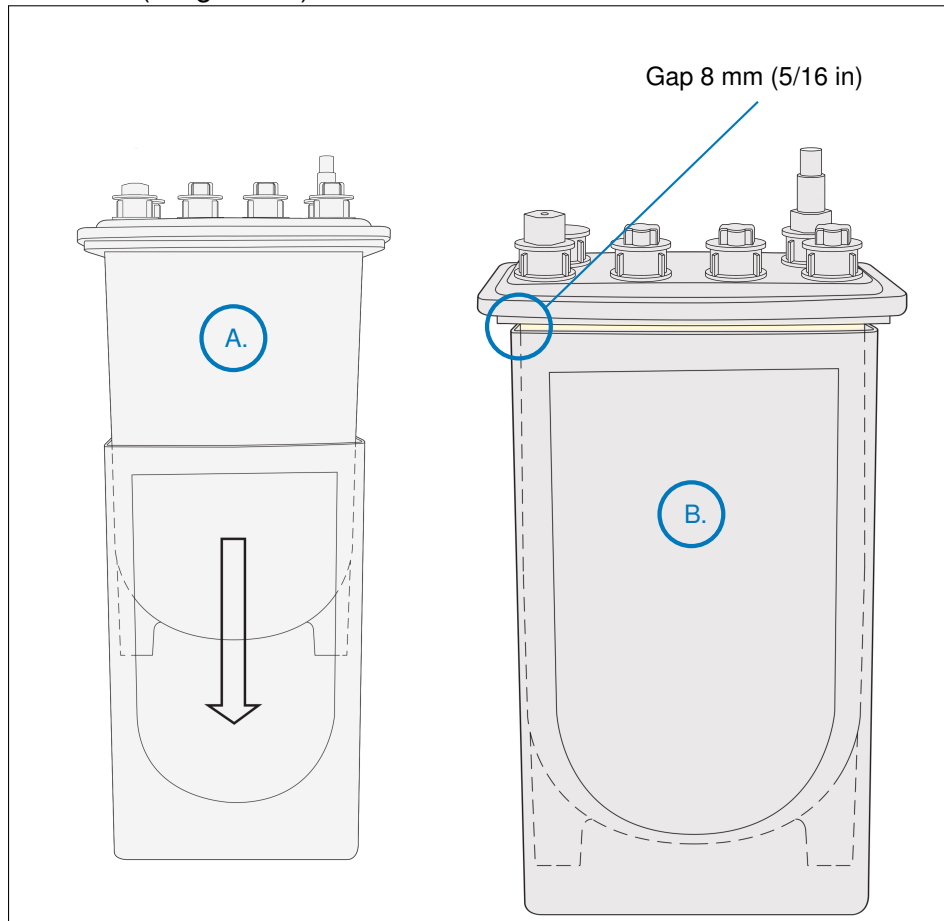

- Remove the tubing sets from their bags. The tubing is labeled with its function.
- Leave the tubing lines on top of the PBS-3 SUS so they do not get in the way during installation.

7. Install the exhaust filter tubing:

- (a) Secure the exhaust filter on the U-channel, so its tubing goes through the two hooks, to the filter, and out of the oven.

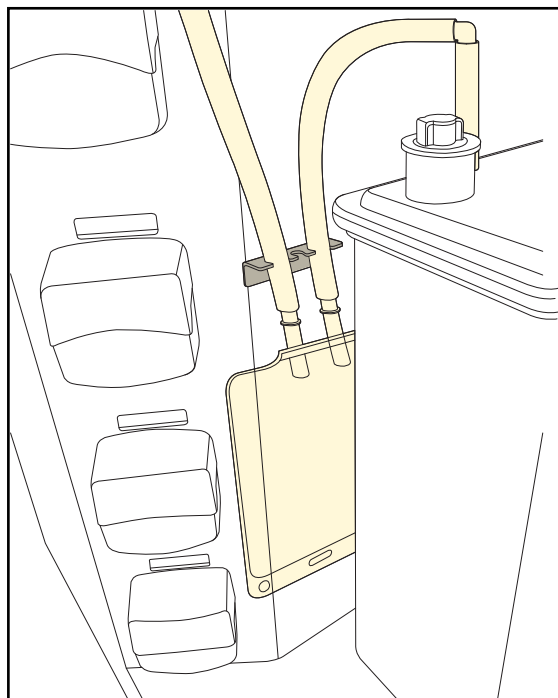
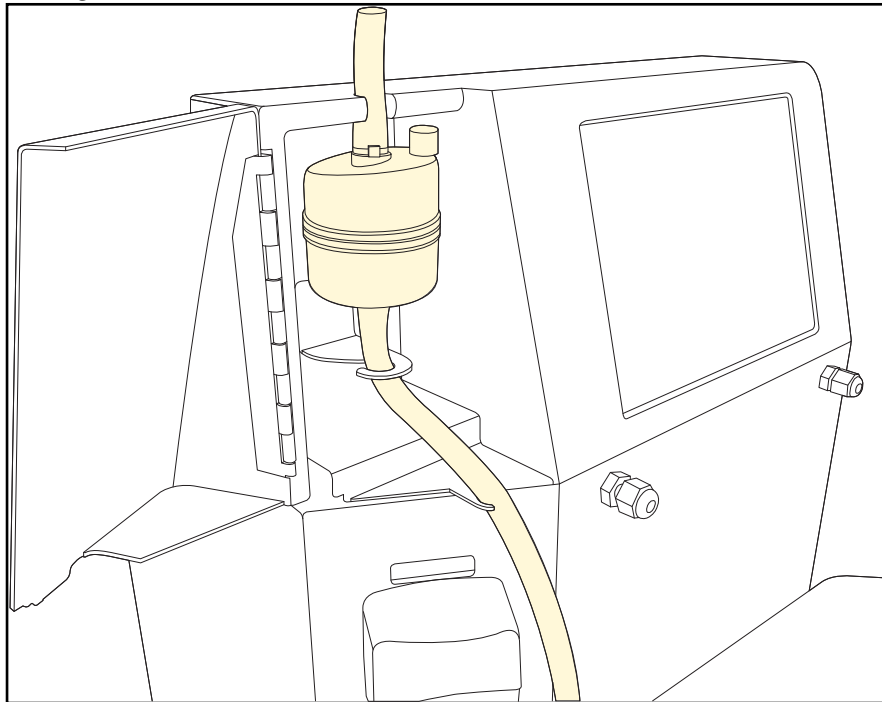

- (b) Install the tubing by the condenser bag in the tubing holder.
- (c) Close the filter oven door.

8. Connect the Air/CO₂/N₂ line to the Air/CO₂/N₂ connector on the PBS-3 SUS.
9. Connect the O₂ overlay line to the O₂ overlay/O₂ sparge connector on the PBS-3 SUS.

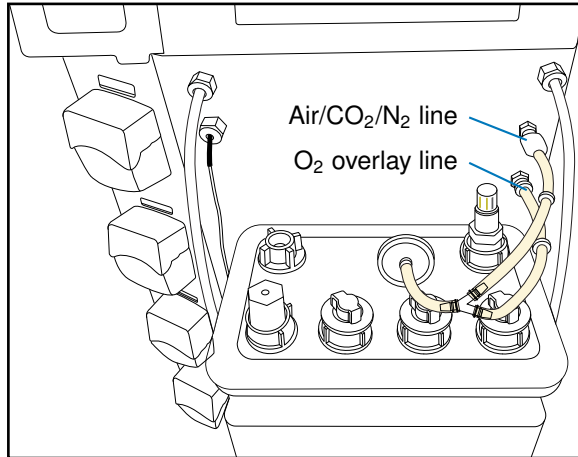

10. Connect the single-use pH and DO sensors:

NOTICE Remove the yellow protective covers from the electrical connectors on the sensors and sensor heads before making any connections.

Note: The single-use pH sensor and DO sensor port come pre-installed in the vessel and sterilized. They do not need to be removed, inserted, or autoclaved.

- (a) Connect the pH sensor head onto the pH sensor by aligning the pH sensor connector with the VP8 receptacle on the sensor head and tightening the locking ring.

Note: Salt deposits may form on the glass surface of the pH sensor probe during dry storage, particularly near the tip, from the electrolyte solution within the sensor. This is considered normal and will dissipate once wetted. The deposit will not cause any cytotoxicity in volumes greater than 250 mL and meets all biocompatibility standards.
- (b) Insert the DO sensor head into the DO sensor port. The sensor will insert into a plastic tube that maintains the sterility of the vessel.

NOTICE The sensor head is retained in the port by gravity. Some sensor heads may have a PG13.5 threaded nut near the top of the sensor. This nut is not intended to engage with the vessel and will rotate freely when the sensor is installed.
- (c) Connect the cables to the DO and pH sensor heads by mating the cable together with its respective sensor and threading the articulating collar completely to secure. Ensure it appears as in image B below, rather than image A below.

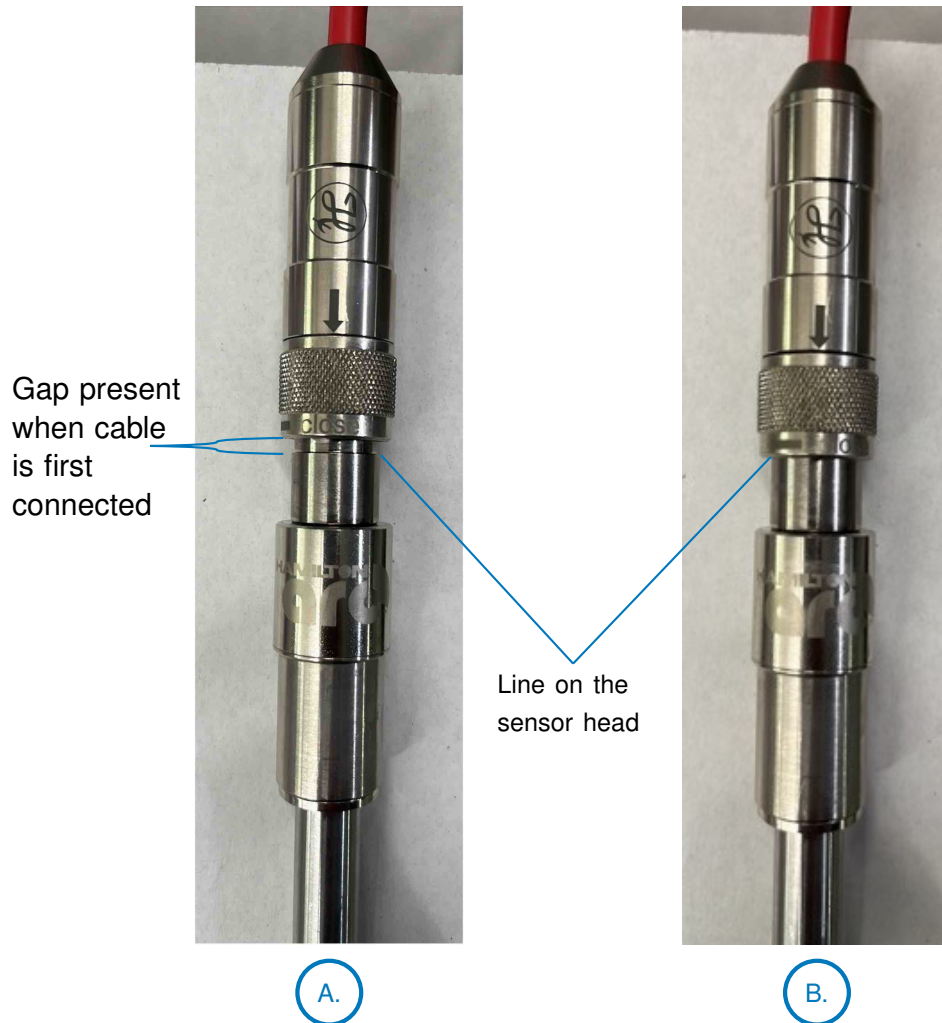

NOTICE When connecting the sensors, do not overtighten, as this may cause damage to the sensors.

11. Insert the temperature sensor in the thermal well.
12. Route the addition line, aspiration line, both media lines, and the harvest line behind the DO sensor and onto the bench next to the PBS-3 SUS.

Level 'Zero' Calibration

1. Install empty vessel containing all sensors and accessories, connect sensor cables, and install tubing in pumps as if during a run.
2. Navigate to the "Actions" tab.
3. Click "Calibrate."
4. Click "Level."

- Click “Zero” if it is not already selected.



- Click “Start Calibration”



- Click “Submit.”
- Verify the new calibration values are appropriate.

9. Click “Save.”
10. Click the arrow in the top left corner to return to the main menu.

Note: Outside of the calibration menu, the Hello UI will report the level PV as “--” when the software recognizes the level PV as exactly 0.0 L. This behavior should be expected after performing a ‘Zero’ calibration or below empty level setting.

Starting a Run

Using the Pumps

This section includes instructions for actually using the pumps. For more information about how they work, see “Control Pumps” on page 144.

The tubing lines on the standard vessel have a silicone section, close to the vessel, and a C-Flex[®] section, at the end. The C-Flex[®] is weldable, but not pumpable, and attempting to pump it can compromise the sterility of the vessel. Only pump the silicone tubing.

NOTICE Depending on the model of vessel being used, some of the tubing lines may not be compatible with the pumps installed on the PBS-3 SUS and will require the use of an external pump.

Tube holder positioning

The pumps must be adjusted for the size of tubing being used. If the outer diameter of the tubing is 1/4 in. or smaller, the “inner” position should be used. For tubing with outer diameter of 5/16 in., the “outer” position should be used.

The pumphead can be adjusted to accommodate 1.6mm wall tubing in sizes from 0.5mm bore to 4.8mm bore.

Tube holder position

Tube bore size	0.5mm	0.8mm	1.6mm	2.4mm	3.2mm	4.0mm	4.8mm
Inner 	✓	✓	✓	✓	✓	✗	✗
Outer 	✗	✗	✗	✓	✓	✓	✓

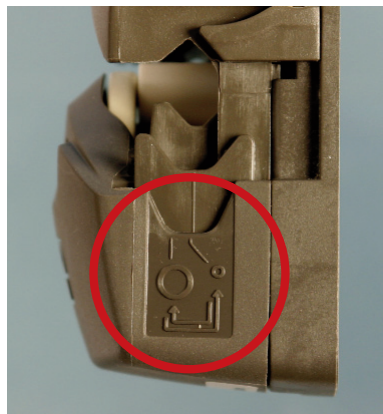

Inner position, for small tubing

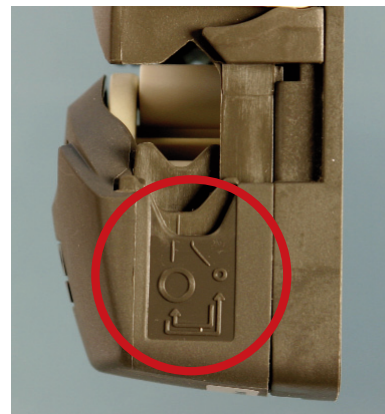

Outer position, for large tubing

With the smaller bore tubes of 0.5mm, 0.8mm and 1.6mm the inner position must be used to prevent the risk of tube slipping through the clamps and wandering across the rollers causing premature tube rupture.

With the larger bore tubes of 4.0mm and 4.8mm the outer position must be used to prevent the flow rate being excessively reduced.

For tubing bores of 2.4mm and 3.2mm either setting may be used, as appropriate for the application. The inner setting will clamp the tube harder, reducing tube slip but has the potential to marginally reduce flow rate. The outer setting will optimise flow rate but the risk of tube slip is increased.

○ → ● To change from the large tube to the small tube setting

Switch off the pump before changing the tube holder position. Use a pointed device such as a ball-point pen to reposition the lower tube holders **on both sides** of the pumphead.



- Lift the flip top until fully open.
- Place the pointed device pointing down into the small depression pictured here.

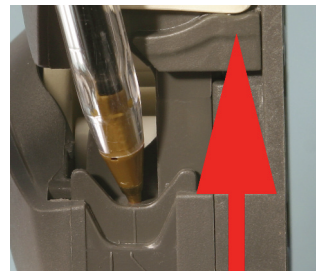
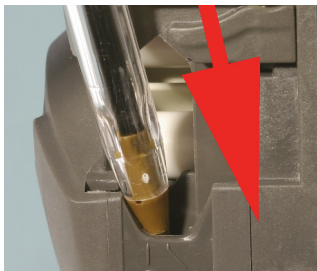

- Press down and slightly away from the front of the pumphead, as shown in the first picture above.
- Maintain the angled downward pressure and push away from the front of the pumphead. The jaw clicks into a new position.
- Release the pressure. The jaw rises into its correct alignment. If it does not rise, repeat the procedure, being sure to maintain downward pressure until release.
- Adjust the tube holder on the other side of the pumphead in the same way.

● → ○ To change from the small tube to the large tube setting

Carry out the procedure described above, but pushing towards the front of the pumphead.

Note: The pictures on the previous page show the tube holders' correct positions for small and large tubing. If a tube holder is not vertical relative to the body of the pumphead, it is wrongly positioned. Follow the instructions above to reposition it.

Tube loading



Switch off the pump before tube loading.

Check that the tube holders on both sides of the pumphead are correctly set for the size of tube you are using.

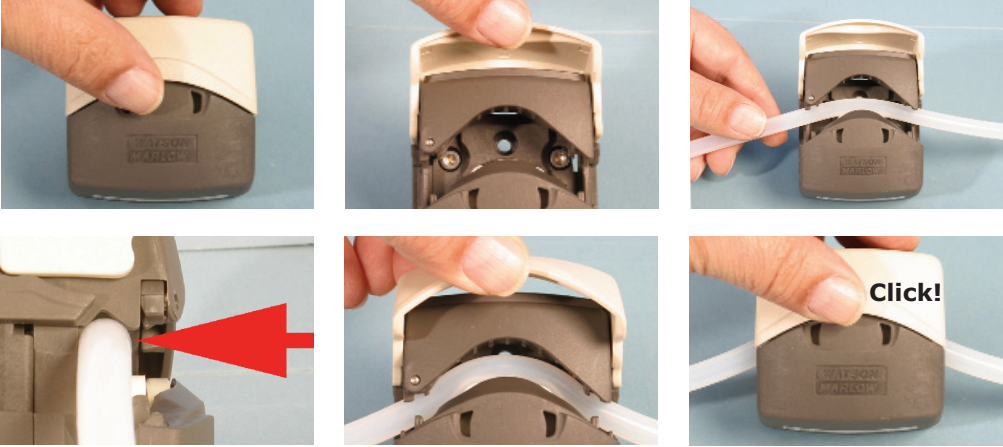

- Lift the flip top until fully open.
- Select enough tube length for the curve of the pump track. Place the tube between the rotor rollers and the track, pressed against the pumphead inner wall. The tube must not be twisted or stretched against the rollers.
- Lower the flip top until it clicks into its fully closed position. The track closes automatically and the tube is stretched correctly as it does so.

Using gravity

To avoid unnecessary wear on the silicone tubing, and exposing cells to unnecessary shear stress, use the pumps only to prime the tubing, and then use gravity for the rest of the liquid transfer when possible.

Accessing the Pumps menu

1. Log in to the Hello UI as a user with the “Controls” permission.
2. Navigate to the “Actions” tab.

3. Click “Control Pumps.”



Adding Medium

To add medium:

1. Navigate to the Pumps menu (see “Accessing the Pumps menu” on page 86).
2. If the media pump is on, click the button to turn it off.
3. Form a sterile connection between the media line and the medium bottle/bag source, by welding the tubing or using the connectors.
4. Install the silicone section of the tubing in the media pump so the arrow points toward the tubing between the pump and vessel (see “Using the Pumps” on page 83).
5. Click the button to turn the media pump on.
6. Click the button to turn the media pump off after adding desired amount of medium.

Level 'Span' Calibration

Level 'Span' Calibration with the Hello UI:

Note: This should only be performed if the Level reading reported by the software is significantly different from the actual volume in the vessel.

1. Confirm no gases are flowing and agitation is off.
2. Navigate to the "Actions" tab.
3. Click "Calibrate."
4. Click "Level."
5. Click "Span."



- Click “Start Calibration”

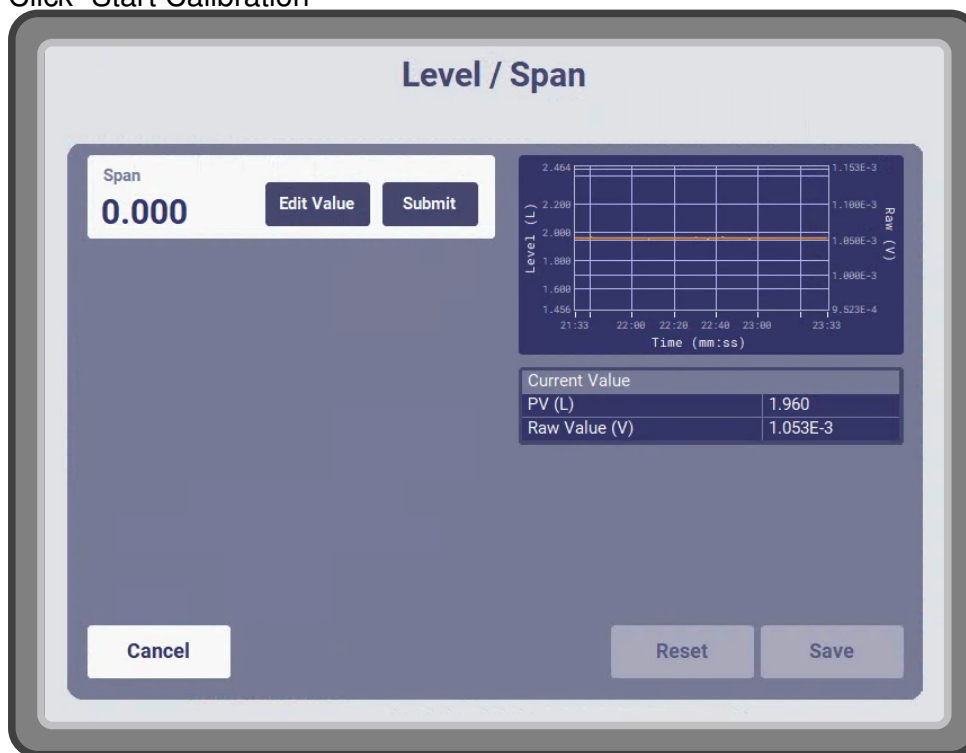

- Click “Edit Value” and use the on-screen keyboard or an external keyboard to enter the correct value in the ‘Span’ field.
- Click “Submit.”
- Verify the new calibration values are appropriate.
- Click “Save.”
- Click the arrow in the top left corner to return to the main menu.

Turning Controls On

After filling the vessel with medium, the controls need to be turned on, to condition the medium. This accomplishes 3 things: (1) it allows the DO and pH sensors to equilibrate, so ‘span’/‘one-point’ calibrations can be performed, (2) it brings the PVs to within the appropriate ranges for the cell process, and (3) it acts as a sterility hold, so operators have the opportunity to determine whether the medium has been contaminated before inoculating.



First, the agitation, temperature, and main gas controllers must be turned on. Then, the DO and pH controllers can be set to Manual mode, to achieve the desired process parameters you intend to use before inoculating. For an explanation why it is recommended to use DO and pH in Manual mode rather than Auto mode before the ‘span’/‘one-point’ calibrations are performed, see “Pre-Calibration Medium Conditioning Strategy” on page 145.

To control the DO in Manual mode, first remember that the DO is scaled so 100% equals atmospheric O₂ conditions. The amount of air entering the vessel and therefore saturating the medium can be displaced with either CO₂ or N₂. For example, to control to a DO PV of 50% with pH set to 5% CO₂, set N₂ to 45% and O₂ to 0%.

To control the pH in Manual mode, set Base to 0% and CO₂% to the value that will provide the desired pH, using the “NaHCO₃, CO₂%, and pH at 37 °C” chart on page 138.

Using controls:

1. Click one of the dashboard buttons (“Agitation,” “Temperature,” “Dissolved Oxygen,” “pH,” or “Main Gas”).
2. Select a mode (Auto, Manual, or Off).

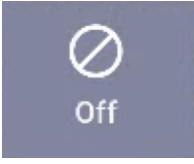
Mode Symbols	
Auto	
Manual	
Off	

3. If Auto mode, enter a set point using the on-screen keypad.

Auto Mode Variables and Set Point Units	
Agitation	Vertical-Wheel® Impeller Revolutions Per Minute
Temperature	Degrees Celsius (°C)
Main Gas	N/A - only Manual mode available
Dissolved Oxygen	% Air Saturation
pH	pH units

Recommended Auto Mode Set Points	
Agitation	15 – 35 RPM if Vertical-Wheel® impeller is fully submerged. 15 – 25 RPM if not.
Temperature	37 °C
Main Gas	N/A - only Manual mode available
Dissolved Oxygen Set Point	25 – 100% Dissolved Oxygen
Dissolved Oxygen Deadband	0 – 5% Dissolved Oxygen
pH Set Point*	6.8 – 7.4 pH units
pH Deadband	0 – 0.05 pH units
Filter Oven	38 °C

*The user must select a base pump from the “Control Pumps” menu for the pH base controller to operate. For more information, see “Selecting a Base Pump” on page 95.

Note: The dissolved oxygen and pH deadbands can be changed in the “Settings” tab. For more information, see “Settings/System Variables” on page 123.

- If Manual mode, enter a controller output using the on-screen keypad.

Note: Other than setting DO and pH to Manual mode before the first ‘span’/‘one-point’ calibrations can be performed, Manual mode is for advanced users ONLY. It is rarely necessary to operate outside of Auto mode, except in the case of the main gas controller, as it has no Auto mode. A sensor error may also necessitate using manual mode until the issue can be resolved, potentially after the cell culture run. Contact PBS Biotech Technical Support for assistance.

Manual Mode Variables and Controller Output Units	
Agitation	Motor % power
Temperature	Main heater % duty
Main Gas	Total gas liters per minute
Dissolved Oxygen – N₂	Total gas % N ₂ composition
Dissolved Oxygen – O₂	Total gas % O ₂ composition
pH – CO₂	Total gas % CO ₂ composition
pH – Base	Base pump % duty

Note: When switching from Manual mode to Auto mode, the controller output will gradually increase or decrease to transition from the user-selected output in Manual mode to the PID-calculated output.

5. Click “Save.”
6. Observe that the dashboard button shows the selected mode and set point or controller output.

‘Span’/‘One-Point’ Calibrations After Equilibration

After the medium has been conditioned and the temperature, DO, and pH have equilibrated, PBS Biotech recommends performing ‘span’/‘one-point’ calibrations on the DO and pH sensors. It is recommended to calibrate the DO sensor first, because calibrating the pH sensor requires taking a sample, and clearing the sample line with air can temporarily change the DO PV.

‘Span’ DO calibration:

The following is recommended for DO calibrations:

- Only perform a ‘span’ DO calibration before inoculating with cells
- Perform the ‘span’ DO calibration using the headspace gas composition as the reference, rather than the measured DO of a sample
- Do not perform additional DO calibrations of any type during a cell culture run

For an explanation, see “Dissolved Oxygen” on page 148.

1. Confirm DO present value has stabilized.
Note: If the medium is 100% air saturated, the DO PV should be between 80% and 120% before performing ‘span’ calibration.
2. Navigate to the “Actions” tab.

3. Click “Calibrate.”
4. Click “DO.”
5. Click “Span.”



6. Click “Start Calibration”



7. Enter the correct DO PV in the 'Span' field. If the only gas flowing into the bioreactor was air, then the medium is 100% air saturated. Otherwise, before inoculating, the DO PV should equal $100 - \text{CO}_2\% - \text{N}_2\%$.
8. Click the "Submit" button.
9. Verify the new calibration values are appropriate.
10. Click "Save."
11. Click the arrow in the top left corner to return to the main menu.
12. Set DO to Auto mode, if desired (see "Turning Controls On" on page 89).

'One-point' pH calibration:

It is recommended to do this before inoculating with cells, and regularly throughout a cell culture run to counteract the pH sensor drift.

1. Take a sample (see "Take Sample" on page 100, "Take Sample" on page 156, and "Sampling for pH Measurement" on page 157). Note pH present value when taking sample.
2. Measure the pH of the sample (see "Sampling for pH Measurement" on page 157).
3. Navigate back to the "Actions" tab.
4. Click "Calibrate."
5. Click "One-point" if it is not already selected.



- Click “Start Calibration”

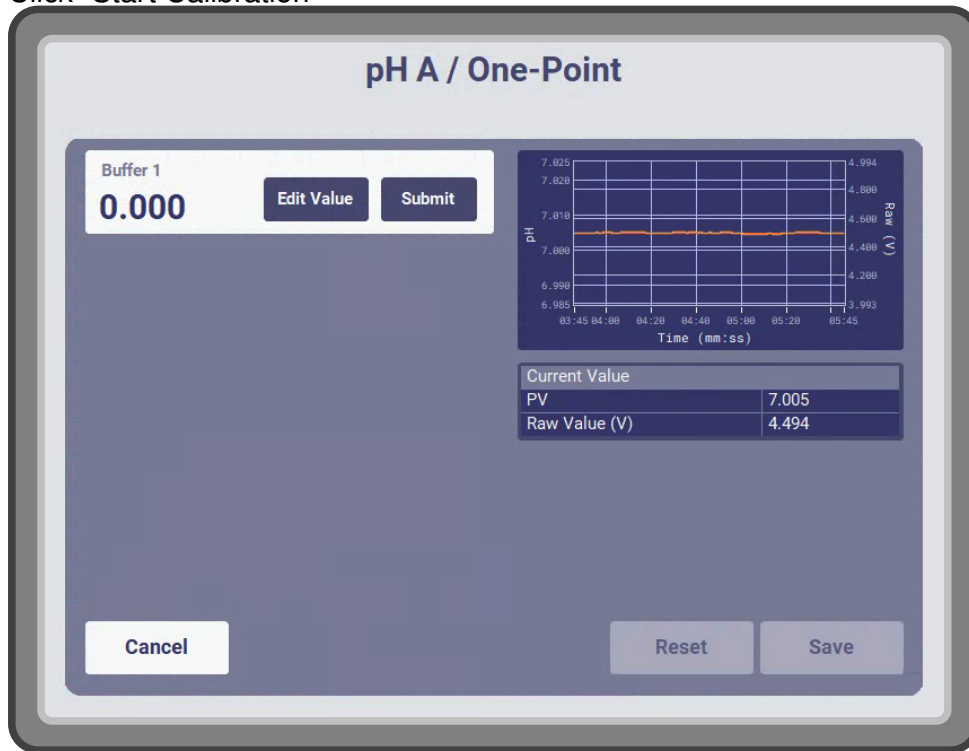

- Enter [(pH PV) – (pH PV when taking sample) + (actual pH of sample)] in the ‘Buffer 1’ field.
- Click the “Submit” button for ‘Buffer 1.’
- Verify the new calibration values are appropriate.
- Click “Save.”
- Click the arrow in the top left corner to return to the main menu.
- Set pH to Auto mode, if desired (see “Turning Controls On” on page 89 and “Selecting a Base Pump” on page 95).

Selecting a Base Pump

PBS Biotech Technical Support recommends configuring the base pump after performing a one-point calibration on the pH sensor and adding cells.

Because pH is usually regulated exclusively by CO₂, base should only be added if absolutely necessary.

The pH controller is configured to expect a solution of 0.5 M of NaHCO₃.

To select a base pump:

- Set pH to “Off” mode.

2. Navigate to the Pumps menu (see “Accessing the Pumps menu” on page 86).
3. Click the drop-down menu beneath “Base Pump” and select “None.”
4. If the desired base pump (Addition A or Addition B) is on, turn it off.
5. Form a sterile connection between the addition line and the base bottle/bag source, by welding the tubing or using the connectors.
6. Install the silicone section of the addition line in the desired addition pump to allow the base to flow into the vessel as the pump rotates clockwise (see “Using the Pumps” on page 83).
7. Confirm that the tubing is not clamped.
8. Set the addition speed to “Slow.”
9. Turn the addition pump on to prime the line.
10. Turn the addition pump off when tubing is primed.
11. Click the drop-down menu beneath “Base Pump” and select the desired addition pump.
12. Select the desired pH mode and set point or controller outputs.

Adding Additional Fluids

It may be necessary to add other fluids throughout a run, such as antifoam solution to control the amount of foam in the vessel. Users can either add additions all at once, or slowly titrate them over a period of time.

To add additional fluids:

1. Navigate to the Pumps menu (see “Accessing the Pumps menu” on page 86).
2. Confirm the desired addition pump is not set to be the base pump.
3. If the desired addition pump (A or B) is on, turn it off.
4. Form a sterile connection between the addition line and the addition bottle/bag source, by welding the tubing or using the connectors.
5. Install the silicone section of the addition line in the desired addition pump to allow the fluid to flow into the vessel as the pump rotates clockwise (see “Using the Pumps” on page 83).
6. Confirm that the tubing is not clamped.
7. Set the desired addition speed.
8. Click the button to turn the addition pump on.

9. Click the button to turn the addition pump off after desired amount has been added, or leave the button in the “on” position to continue titrating.

Load the Alarms On.alm File

After sensors have been calibrated and the important variables are within the appropriate ranges for your cell line/process, it is important to activate alarm notification before inoculating.

Alarm notification is activated by loading a different Alarms.alm file. Until this point, the Alarms Inactive.alm file should have been loaded. This file ignores the alarms which would be triggered while setting up for a run, such as the PVs being too low or too high before turning on controls. Because these alarms should not be ignored during a run, the Alarms On.alm file, or another Active alarms file that a user has configured and saved for this purpose, should be loaded at this time.

1. Confirm the Process Alarms settings for your run. Note that if a setting is configured such that the PV is outside the appropriate range, an alarm will be generated immediately after loading the Alarms On.alm file. For more information, see “Settings/System Variables” on page 123.
2. Load the Alarms On.alm file, or other desired Active file a user has configured and saved for this purpose. For more information, see “Configuring Alarm Settings” on page 55.
3. For how to view and acknowledge alarms, see “Alarms” on page 122.

Inoculate with Cells

When sensors have been calibrated and important variables are within the appropriate ranges for your cell line, it is safe to add the cells.

To inoculate:

1. Navigate to the Pumps menu (see “Accessing the Pumps menu” on page 86).
2. If the media pump is on, click the button to turn it off.
3. Form a sterile connection between the media line and the cell bottle/bag source, by welding the tubing or using the connectors.
4. Install the silicone section of the tubing in the media pump so the arrow points toward the tubing between the pump and vessel (see “Using the Pumps” on page 83).
5. Check that the tubing clamp is open, and its branched tubing clamp is closed, if applicable.

6. Click the button to turn the media pump on.
7. Click button to turn the media pump off after adding cells.

Entering Batch Name

To name a batch:

1. Navigate to the “Actions” tab.
2. Click “Batch.”

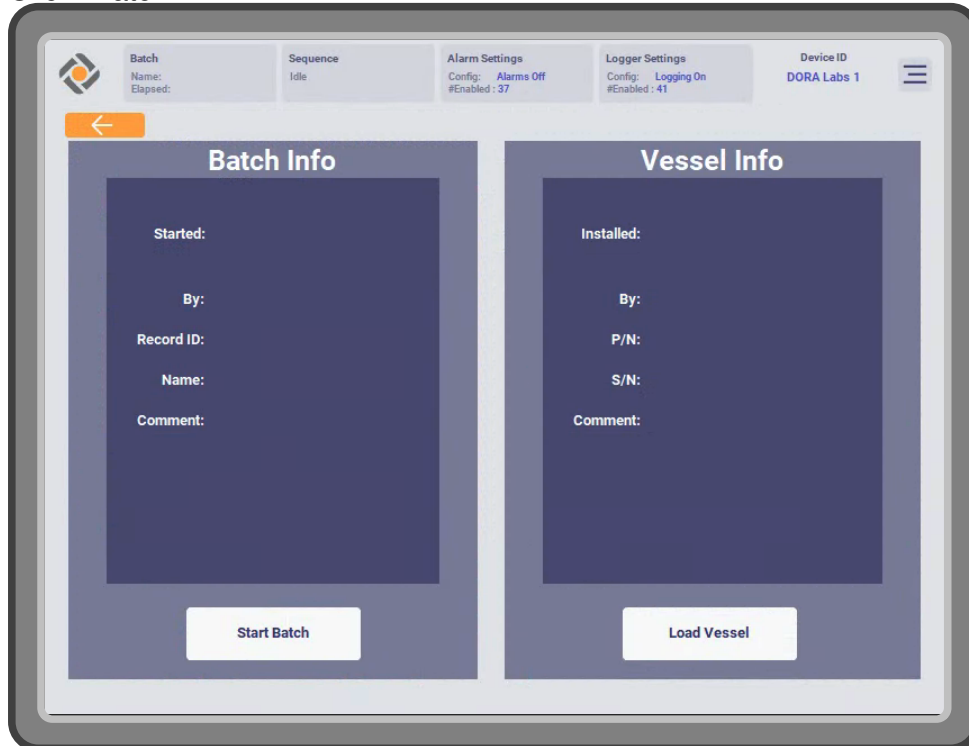

3. If a batch is running, end it:
 - (a) Click “End Batch.”
 - (b) Confirm by clicking “Confirm” in the overlay.

- Click “Start Batch.”

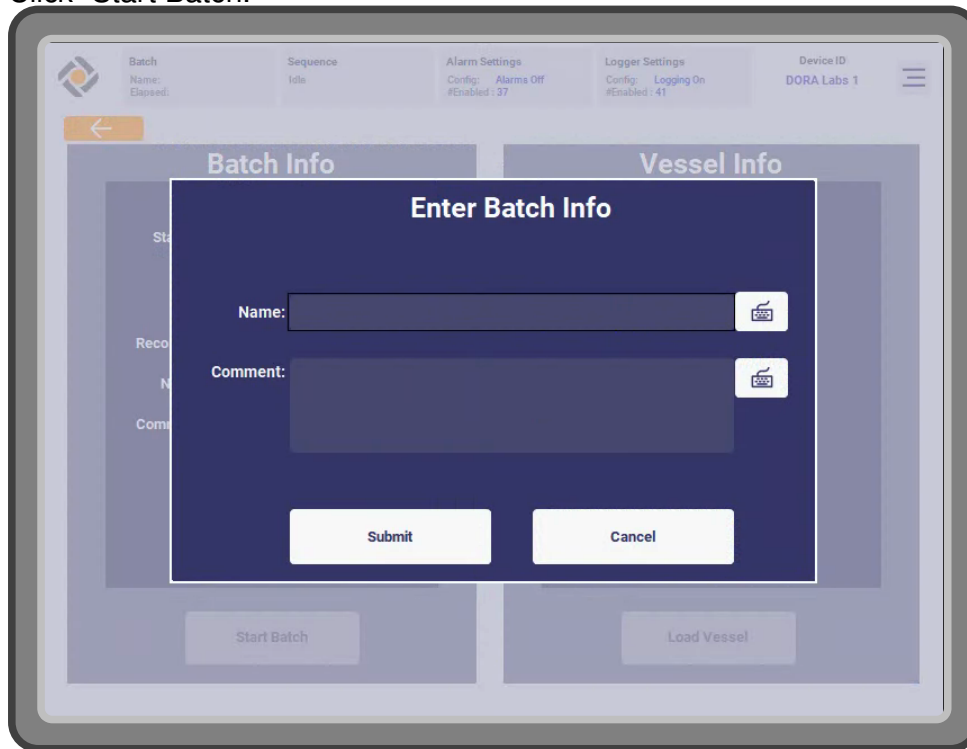

- Use the on-screen keyboard, or an external keyboard, to enter a batch name 16 characters or less.
- Enter a comment, if desired.
- Click “Submit.”
- Observe that the Information Bar now displays the entered batch name, the start time, and the elapsed time.

Take Sample

For information about concerns when taking a sample, handling the sample, and measuring a sample, see “Take Sample” on page 156.

The following sub-sections are not exhaustive, and there are likely many additional ways for operators to take a sample out of the bioreactor without compromising the sterility of the vessel.

Note: A sample of 10 mL or larger is recommended for cell counts.

PBS-3 SUS vessel’s sample line

Sampling manifold assemblies similar to the one depicted here can be purchased from PBS, already sterilized and ready to be sterilely welded onto a vessel. Contact PBS Sales for more information.

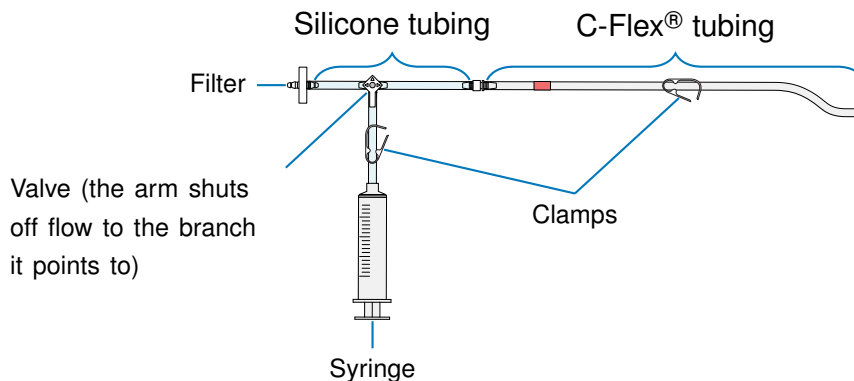

To take a sample with the vessel’s sample line and a pump:

Using a pump to take a sample can decrease the sampling variability between operators. It can also, however, expose the sample to more shear stress. For instructions on how to take a sample without using a pump, see “To take a sample with the vessel’s sample line, single-syringe pull, and gravity drain” on page 104 and “To take a sample with the vessel’s sample line and dual-syringe pull” on page 106.

1. Log in to the Hello UI.
2. Navigate to the “Actions” tab.

3. Click “Sample.”



4. Unclamp all clamps on the sample line.

5. Clear the sample line of air, to minimize the amount of air that will end up in the syringe:
 - (a) Install the silicone tubing between the valve and vessel in the sample pump as in the image below.
 - (b) Configure the valve to block flow to the syringe. This will push the air in the sample line out of the filter.
 - (c) Configure the sample pump to flow counter clockwise (CCW).
 - (d) Turn the sample pump on. Be prepared to execute the next step.

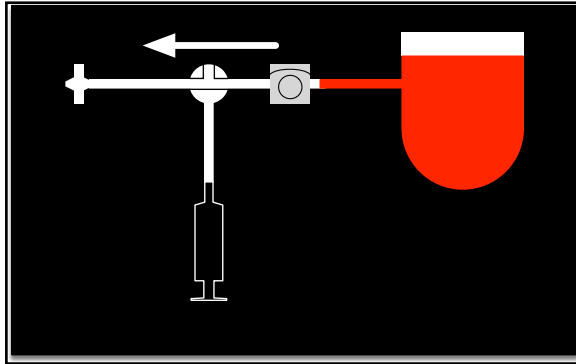

6. Bring the sample into the syringe:
 - (a) Shortly before the liquid reaches the sample pump (as in the image above), change the direction of the valve to block flow to the filter. This will bring the liquid from the vessel into the syringe (as in the image below). Not changing the valve direction in time risks wetting the filter, which can clog it and prevent other samples from being taken.
 - (b) When there is sufficient sample in the syringe, stop the sample pump.

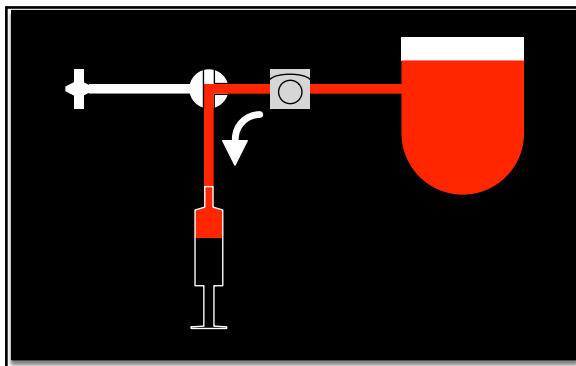

7. Clamp the line between the valve and syringe, and remove the tubing from the sample pump.

8. Push the remaining liquid between the valve and syringe into the syringe:
 - (a) Install the tubing between the filter and valve in the sample pump as in the image below.
 - (b) Configure the valve to block flow to the vessel. This will push filtered air into the syringe, clearing the line between the valve and syringe of liquid.
 - (c) Unclamp the line between the valve and syringe.
 - (d) Configure the sample pump to flow clockwise (CW).
 - (e) Turn the sample pump on. Be prepared to execute the next step.

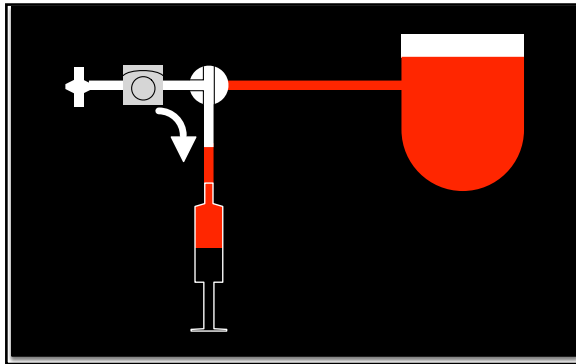

9. Push the remaining liquid between the valve and vessel back into the vessel:
 - (a) When the line between the valve and syringe is clear of liquid, configure the valve to block flow to the syringe. This will push filtered air into the vessel, clearing the line between the valve and vessel of liquid.

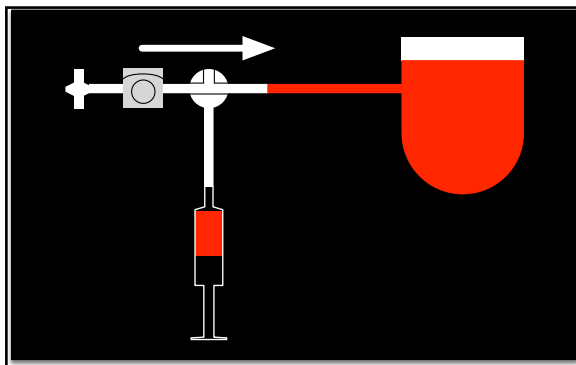

10. When bubbles form in the vessel it means the line is clear of liquid. Turn off the sample pump.
11. Clamp the sample line, and remove the syringe. Using proper aseptic technique, either replace the syringe with a sterile one, or weld on a new sampling manifold.
12. If sampling to measure pH or DO, expel the head gas from the syringe, and cap it to make the sample more stable. Measure the pH or DO as

soon as possible.

Note: Some users find that the Sample pump flows too quickly, and prefer using an Addition pump set to 'Slow' speed instead. The Addition pumps are controlled in the "Control Pumps" menu. Because they are not bi-directional, the tubing would have to be clamped and the manifold turned around at specific points in the Manual Sampling operation.

To take a sample with the vessel's sample line, single-syringe pull, and gravity drain:

Taking a sample without using a pump can expose the sample to less shear stress. It can also, however, introduce more sampling variability between operators. This method also exposes the sample to much more air than the other methods using the sample line, and is therefore not appropriate for measuring the pH or DO of the sample. For an alternative method of taking a sample without using a pump, see "To take a sample with the vessel's sample line and dual-syringe pull" on page 106. For instructions on how to take a sample using a pump, see "To take a sample with the vessel's sample line and a pump" on page 100.

1. Unclamp all clamps on the sample line.
2. Pull the sample into the sample syringe:
 - (a) Configure the valve to block flow to the filter. This will allow the sample syringe to pull the liquid from the vessel into the sample syringe.
 - (b) Pull the sample from the vessel using the sample syringe. Note that you will first be pulling the air in the sample line into the syringe.
 - (c) When there is sufficient sample in the syringe, stop pulling.

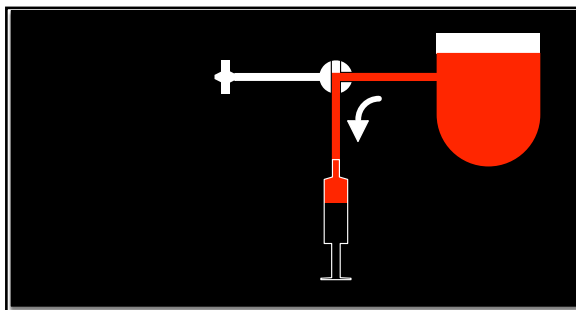

3. Pull the remaining liquid between the valve and sample syringe into the sample syringe:
 - (a) Configure the valve to block flow to the vessel. This will allow the sample syringe to pull filtered air into the sample syringe, clearing the line between the valve and sample syringe of liquid.
 - (b) Pull air from the air transfer syringe through the filter and into the sample syringe.
 - (c) Stop pulling air into the sample syringe once the line between the valve and sample syringe is clear of liquid.

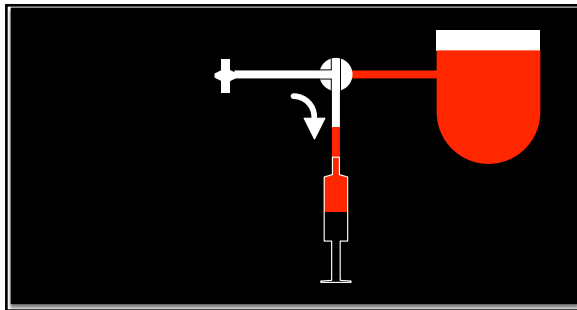

4. Drain the remaining liquid between the valve and vessel back into the vessel:
 - (a) Hold the filter and valve above the liquid level line of the vessel.
 - (b) Configure the valve to block flow to the sample syringe. This will allow air to pass through the filter and into the vessel, clearing the sample line.
 - (c) Raise the sample line above the liquid level line of the vessel, to allow gravity to drain as much of the liquid as possible back into the vessel.

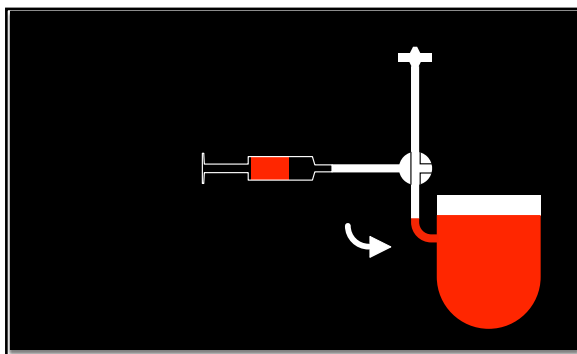

5. Clamp the sample line, and remove the syringe. Using proper aseptic technique, either replace the syringe with a sterile one, or weld on a new sampling manifold.

To take a sample with the vessel's sample line and dual-syringe pull:

This method requires a 60 mL syringe or similar, installed on the filter on the vessel's sample line. Taking a sample without using a pump can expose the sample to less shear stress. It can also, however, introduce more sampling variability between operators. For instructions on how to take a sample using a pump, see “To take a sample with the vessel's sample line and a pump” on page 100. For an alternative method for taking a sample without a pump, see “To take a sample with the vessel's sample line, single-syringe pull, and gravity drain” on page 104.

Sampling manifold assemblies similar to the one depicted here can be purchased from PBS, already sterilized and ready to be sterilely welded onto a vessel. Contact PBS Sales for more information.

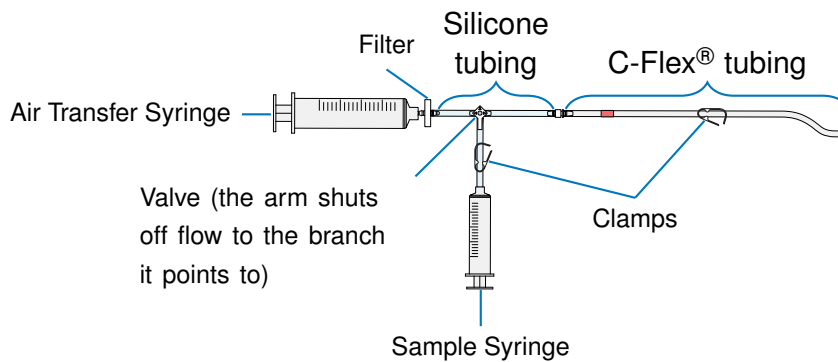

1. Install a 60 mL syringe or similar on the filter on the sample line. Instructions will refer to this as the “air transfer syringe.”
2. Unclamp all clamps on the sample line.

3. Clear the sample line of air, to minimize the amount of air that will end up in the sample syringe:
 - (a) Configure the valve to block flow to the sample syringe. This will allow the air transfer syringe to pull the air in the sample line through the filter and into the air transfer syringe.
 - (b) Using the air transfer syringe, pull air out of the sample line.
 - (c) Stop before the liquid in the vessel gets to the valve. Continuing to pull liquid past the valve risks wetting the filter, which can clog it and prevent other samples from being taken.

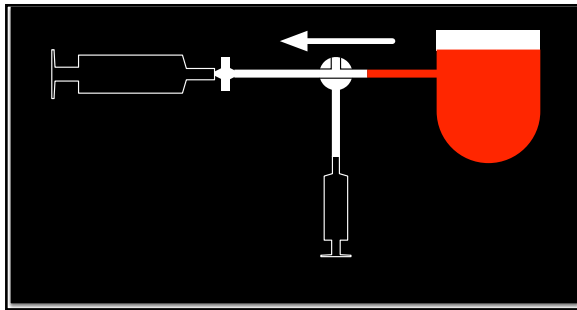

4. Pull the sample into the sample syringe:
 - (a) Change the direction of the valve to block flow to the filter. This will allow the sample syringe to pull the liquid from the vessel into the sample syringe.
 - (b) Pull the sample from the vessel using the sample syringe.
 - (c) When there is sufficient sample in the syringe, stop pulling.

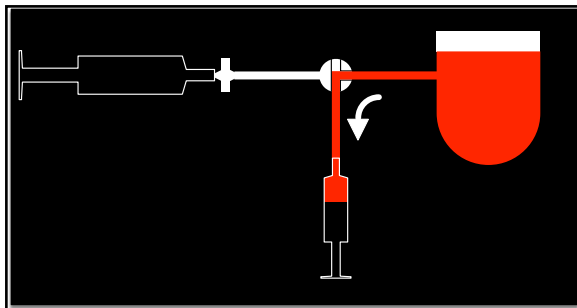

5. Push the remaining liquid between the valve and sample syringe into the sample syringe:
 - (a) Configure the valve to block flow to the vessel. This will allow the air transfer syringe to push filtered air into the sample syringe, clearing the line between the valve and sample syringe of liquid.
 - (b) Push air from the air transfer syringe through the filter and into the sample syringe.
 - (c) Stop pushing air into the sample syringe once the line between the valve and sample syringe is clear of liquid.

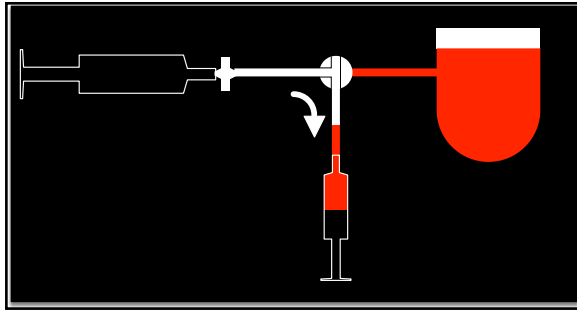

6. Push the remaining liquid between the valve and vessel back into the vessel:
 - (a) Configure the valve to block flow to the sample syringe. This will allow the air transfer syringe to push the air in the air transfer syringe through the filter and into the vessel, clearing the sample line.
 - (b) Using the air transfer syringe, push air into the sample line. You will likely have to disconnect the air transfer syringe, pull more air into it, and reconnect it to the filter to completely clear the sample line. Because the air is being pushed through the filter, this will not compromise sterility.
 - (c) When bubbles form in the vessel it means the sample line is clear of liquid. Stop pushing air through the air transfer syringe at this point.

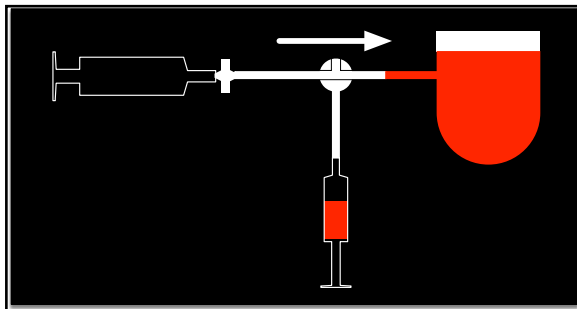

7. Clamp the sample line, and remove the syringe. Using proper aseptic technique, either replace the syringe with a sterile one, or weld on a new sampling manifold.

8. If sampling to measure pH or DO, expel the head gas from the syringe, and cap it to make the sample more stable. Measure the pH or DO as soon as possible.

To take a sample from the dip tube:

Note: Two operators are necessary for this section.

Note: This assumes the dip tube's tubing line routes to a small (250 mL – 500 mL) transfer flask, i.e. one with a short dip tube.

1. Log in to the Hello UI.
2. Navigate to the "Actions" tab.
3. Click "Control Pumps."
4. Position the dip tube tubing in the Media pump so the flow is toward the transfer flask at the end of the dip tube assembly.
5. Put 2 50 mL conicals in the biosafety cabinet. Label one for 'Waste' and the other for 'Sample.'
6. Put the transfer flask at the end of the dip tube assembly in the biosafety cabinet.
7. Operator A: Remove the transfer cap and hold its dip tube over the 'Waste' conical.
8. Operator B: Unclamp the dip tube line and turn the pump on.
9. Operator A: Instruct Operator B to turn the pump off when 5 mL or more has gone into the 'Waste' conical. This clears the line of settled microcarriers and excess media.
10. Operator B: Turn the pump off when directed.
11. Operator A: Hold the transfer cap's dip tube over the 'Sample' conical.
12. Operator B: Turn the pump on.
13. Operator A: Instruct Operator B to turn the pump off when enough liquid has entered the 'Sample' conical.
14. Operator B: Turn the pump off when directed. Clamp the line.
15. Operator A: Install the transfer cap back in the transfer flask.
16. Operator B: Position the dip tube tubing in the Media pump so the flow is toward the vessel.
17. Operator B: Unclamp the dip tube line and turn the pump on.
18. Operator B: Turn the pump off and clamp the dip tube line when the line is clear and bubbles are pushed through the end of the dip tube in the vessel.

Exchanging Medium

1. Form a sterile connection between the appropriate aspiration line or dip tube line and the waste media bottle/bag destination by welding the tubing or using the sterile connectors. The volume of settled cells should be less than the aspiration level of the selected tubing line.
2. Load the Alarms Inactive.alm file (see “Load the Alarms On.alm File” on page 97).
3. Turn temperature off, and wait 2 minutes before turning agitation off (below). This is to allow the heater plate(s) to cool before cells settle on it.
4. Change DO and pH from Auto mode to Manual mode, setting the requested N₂, O₂, and CO₂ flows to match what was called for while in Auto mode.
Users should continue to request gas flow while removing medium from the vessel to maintain a reasonable amount of pressure within the vessel.
5. Turn agitation off.
6. Sparging gas will interfere with the cells settling to the bottom of the vessel. Disconnect the O₂ sparge line, if being used to sparge O₂, to prevent sparging gas while cells are settling. Route O₂ through the headspace.
7. Wait for the cells to settle to the bottom of the vessel. The aspiration port or the end of the dip tube should be above the settled volume of cells. If not, either change which aspiration line is connected to the waste media bottle/bag, or (if the dip tube is being used), bring the vessel into the biosafety cabinet, and (being careful not to insert the dip tube further into the vessel) loosen the dip tube, raise part out of the vessel, and re-tighten it.
8. Check that the aspiration line or dip tube line tubing clamp is open, and its branched tubing clamp is closed, if applicable.
9. Install the silicone section of the tubing in the media pump so the arrow points toward the tubing between the pump and waste media bottle/bag.
10. Remove the desired amount of spent medium.
11. Reattach the O₂ sparge line, if applicable.
12. Add fresh medium (see “Adding Medium” on page 87).
13. Turn agitation back on, and set DO and pH to the original desired modes.
14. When settled cells/aggregates/microcarriers are resuspended, turn temperature back on.

15. Load the Alarms On.alm file (see “Configuring Alarm Settings” on page 55 and follow the relevant instructions).

Note: If performing multiple medium exchanges, reposition tubing through the pump head if it starts to wear out in order to pump with a fresh section of tubing.

Harvesting a Run

To harvest:

1. Load the Alarms Inactive.alm file (see “Load the Alarms On.alm File” on page 97).
2. Set all control modes to Off.
3. Navigate to the “Actions” tab.
4. Click “Control Pumps.”
5. If the media pump is on, click the button to turn it off.
6. Form a sterile connection between the harvest line and the harvest bottle/bag destination by welding the tubing or using the sterile connectors.
7. Check that the tubing clamp is open, and its branched tubing clamp is closed, if applicable.
8. Install the silicone section of the tubing in the media pump so the arrow points toward the tubing between the pump and harvest bottle/bag destination.
9. Click the button to turn the media pump on.
10. Click the button to turn the media pump off after removing culture.
11. Turn off all pumps.
12. Set base pump to “None.”
13. Turn off the light, if it is on.
14. End batch (see “Entering Batch Name” on page 98).
15. Remove the vessel.

NOTICE Disconnect and save the DO and pH sensor heads - they are not part of the single-use vessel (see “PBS-3 SUS Bioreactor - Sensors” on page 16). When removing the dip tube from the vessel, be sure to retrieve the transparent o-ring necessary for sealing and keep it with the dip tube (it can slide off and remain in the probe ports and be accidentally disposed of).

16. Go to the “Actions” tab, click “Batch,” and click “End Batch” and then “Unload Vessel.”
17. Clean/decontaminate the PBS-3 SUS (see “Cleaning and Decontamination” on page 33).

Note: If performing multiple harvests, reposition tubing through the pump head if it starts to wear out, to pump with a fresh piece.

Other Features

Filter Oven

The Filter Oven heats the exhaust filter on the vessel, preventing moisture from accumulating in it and clogging it. The PBS-3 SUS is designed to always have the Filter Oven in Auto mode, at 38 °C. The Filter Oven interlock effectively turns off the Filter Oven between cell culture runs (see “Interlocks” on page 130 and “Filter Oven” on page 143). For this reason, PBS Biotech Technical Support does not recommend setting the Filter Oven to Off mode. If users still want to turn it off between runs, they need to make sure to turn it on before adding medium.

To change the filter oven mode:

1. Navigate to the “Actions” tab.
2. Click “Advanced” (see “Advanced View” on page 121).
3. Click the “Filter Oven” button.
4. Change the mode and/or set point, like with the other controllers.

Sequences

Creating or editing sequences

1. Log in to the Hello UI as a user with the “Sequence Editor” permission.

2. Navigate to the “Actions” tab and click “Sequence.”

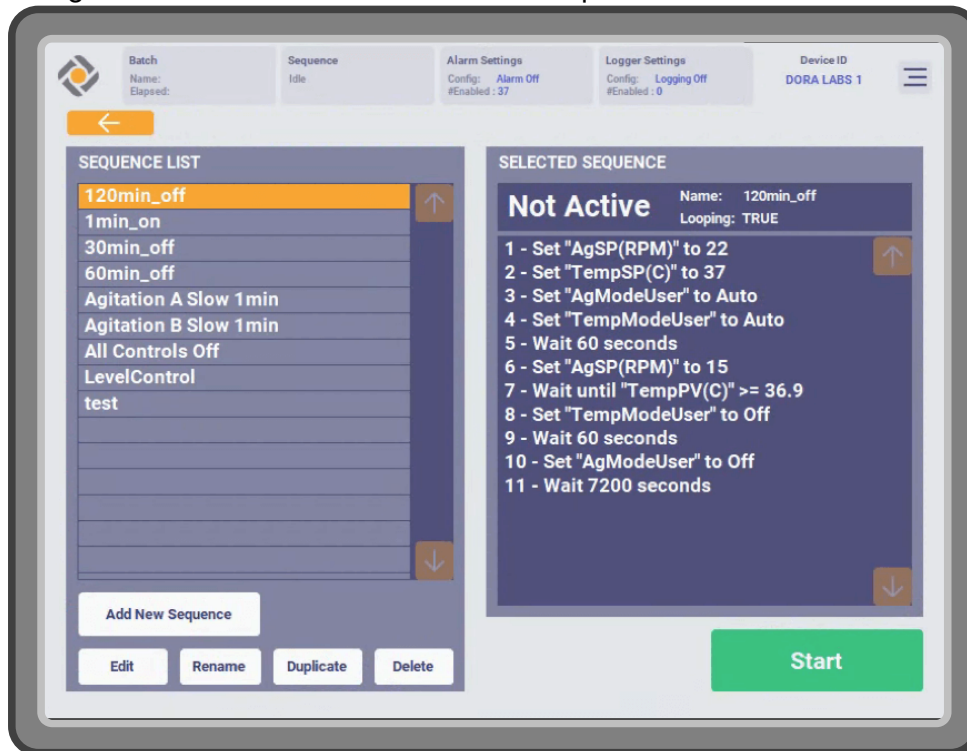

3. Click “Add New Sequence” to create a new sequence. Select an existing sequence to edit, rename, duplicate, or delete it. You cannot edit, rename, or delete a sequence while it is running.

4. When creating a new sequence or renaming or duplicating an existing one, use either the on-screen keyboard or an external keyboard to enter the name.



5. This is the editor.



- | | |
|--|---|
| <ul style="list-style-type: none"> (a) The name of the sequence being edited (b) Whether the sequence will run once, or run in a loop (c) Move the selected step up by 1 (d) Move the selected step down by 1 (e) Move the selected step to be first (f) Move the selected step to be last (g) Save the changes (h) Revert the changes | <ul style="list-style-type: none"> (i) Duplicate the selected step (j) Delete the selected step (k) Add a step after the selected step (l) 'Set' steps change the value of a parameter to a number (m) 'Wait' steps wait a specific amount of time before proceeding (n) 'Wait Until' steps wait until a parameter's value meets a comparison condition before proceeding |
|--|---|

6. Configure the sequence as desired, and save it.

Running sequences

1. Log in to the Hello UI as a user with the "Start Sequence" permission. The "End Sequence" permission is required to end a sequence while it is running.

2. Navigate to the “Actions” tab and click “Sequence.”
3. Select a sequence from the list. You will be able to review its steps before running.
4. Click the “Start” button to start the selected sequence.

For more on sequences, see “Sequences” on page 153.

Generating Reports

NOTICE The reports are generated in .csv format. Because many spreadsheet applications, such as Excel, have limited .csv functionality (they may not save the timestamp values properly in a .csv file, for example), once users open the .csv file in their preferred spreadsheet application, they should “Save As” an application-specific file type (e.g. .xls), and graph and analyze the data in that file rather than in the .csv file.

1. Log in to the Hello UI as a user with the “Reports” permission.
2. Navigate to the “Actions” tab.
3. Click “Reports.”
4. Choose a batch or time span.

The screenshot displays the 'Generate Report' interface. At the top, there is a title 'Generate Report' and a back arrow. Below the title, a 'Steps' section lists four steps: 1. Select Batch or Date Range (highlighted in orange), 2. Select Report Type, 3. Generate, and 4. Export Data. To the right of the steps, there are input fields for 'Batch' and 'Date'. Below these, there are fields for 'From' (2023/2/7) and 'Start Time' (00:00), and 'To' (2023/2/8) and 'End Time' (00:00). A 'Next' button is located at the bottom right of the form.

5. Select a Report Type. The number of records for the selected report type in the selected batch or time span will be displayed on the screen. If there are no records for the selected report type in the selected batch or time span, the report cannot be generated. For more information on Report Types, see “Types” on page 155.

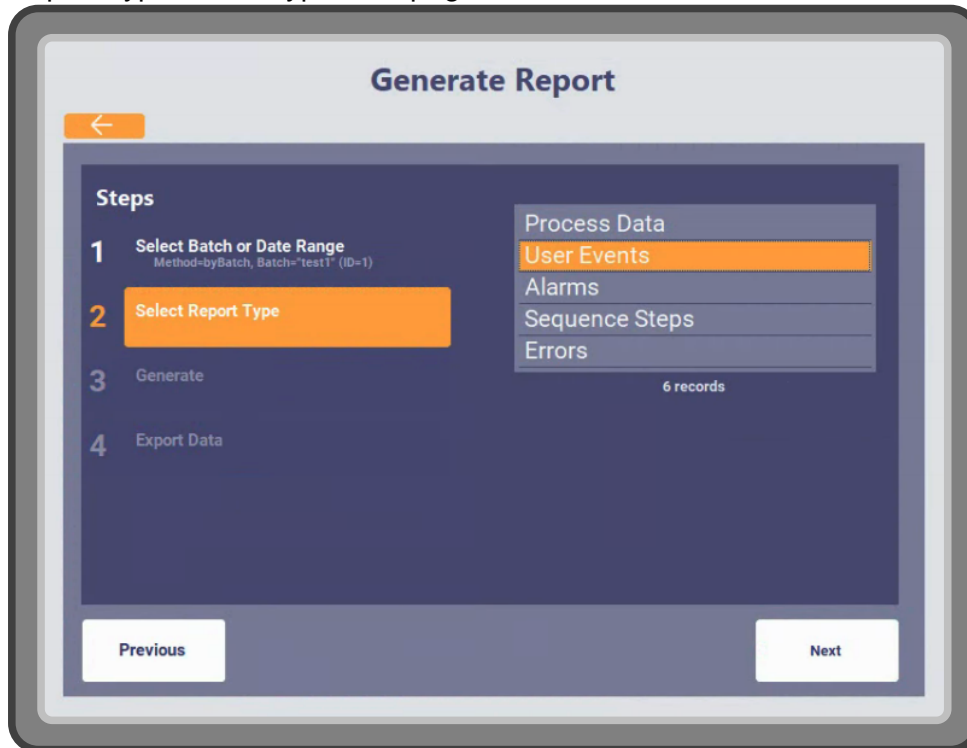

- 6. Modify the name and/or description, if desired, then generate the report. The default name is formatted as follows:
ReportType_YYYY-MM-DD_hh-mm-ss

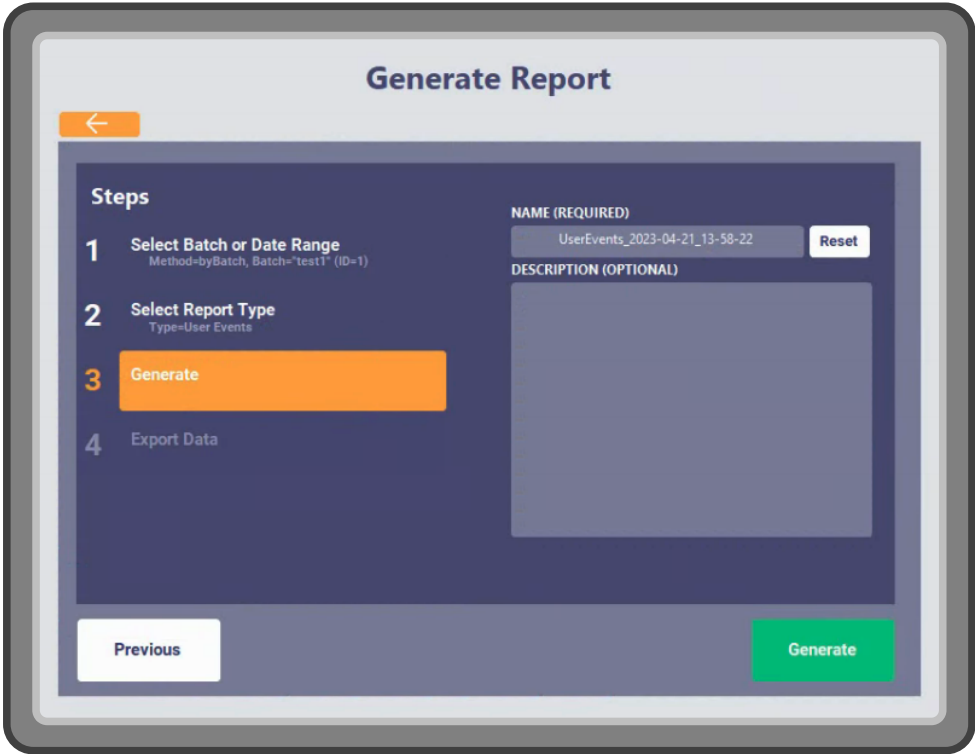

- 7. After the report has been generated, it can be exported, either via email, to a connected USB drive, or to a connected network drive.

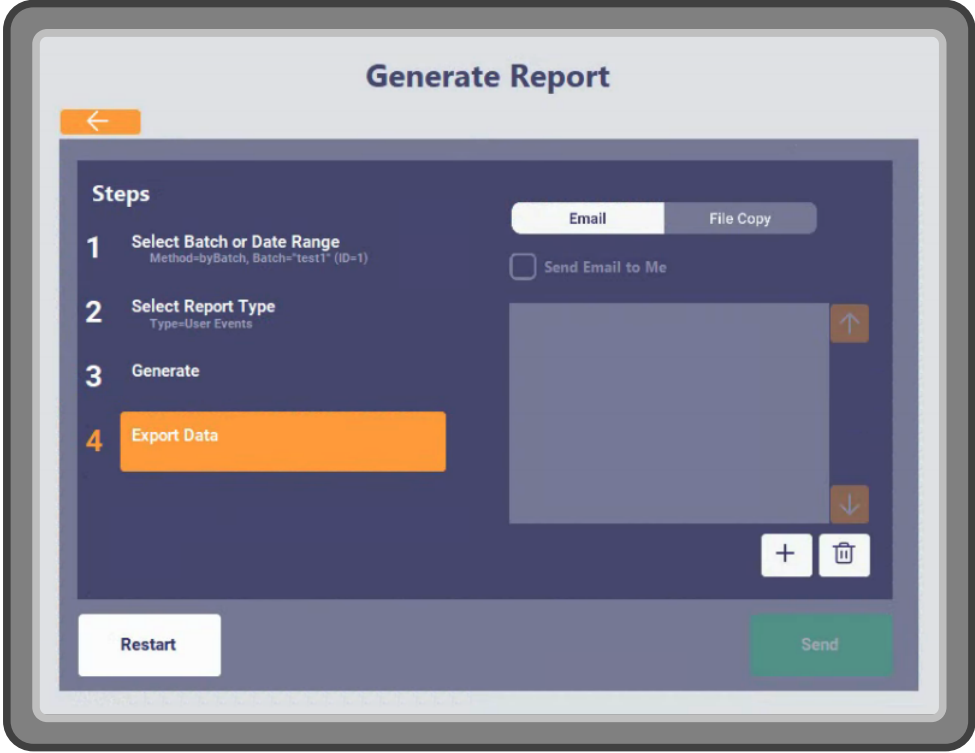

You can email it to the address associated with your user account, enter individual email addresses, or email the report to all users in a user group.

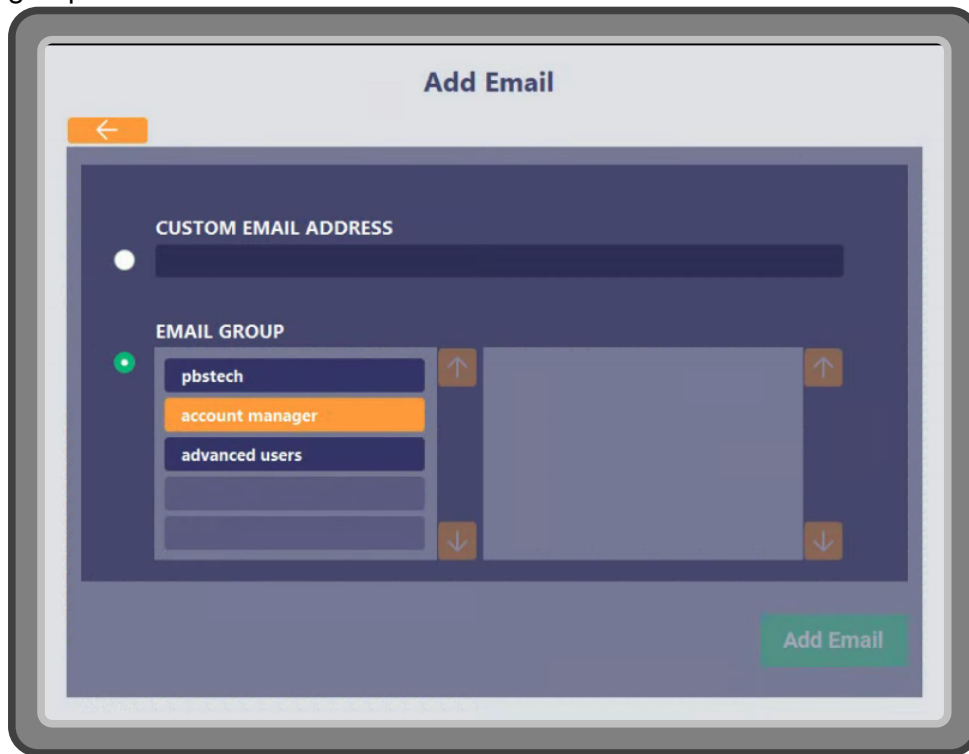

Light

To use the light with the Hello UI:

1. Navigate to the “Actions” tab.
2. Click “Main Light” to turn the light on. The button will change from white to blue.

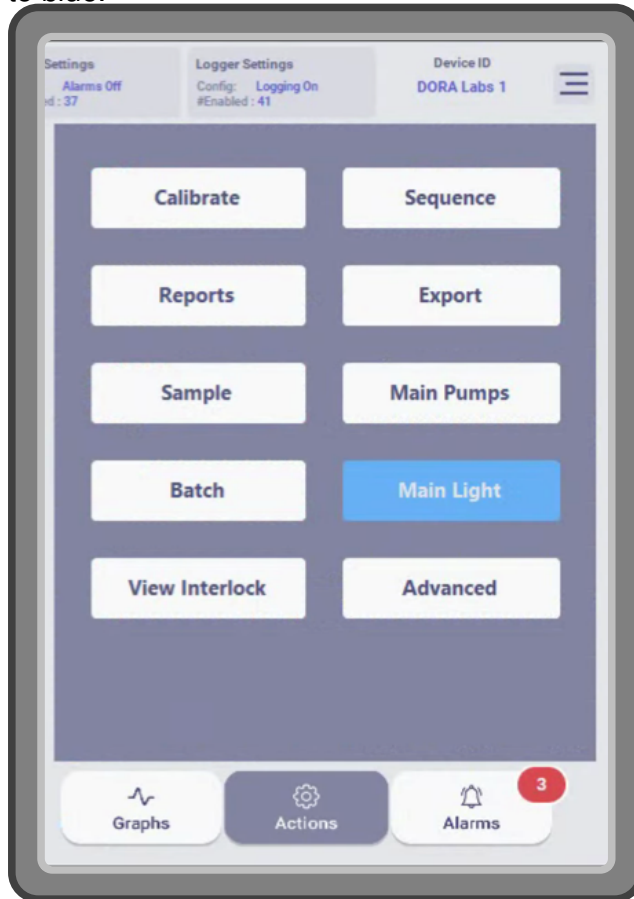

3. Click “Main Light” to turn the light off. The button will change from blue to white.

Advanced View

In addition to all the data displayed in the Dashboard and button functions, the Advanced View menu also displays the Controller Outputs for each controller, and the filter oven temperature. The Output column shows the controller output being requested by the software for each controller. The actual flow rates for each MFC are reported in the row at the bottom of the menu. For example, if the user requests 50% N₂ flow but there is no source pressure to the N₂ MFC, the Dissolved Oxygen Controller Output will show 50% N₂, but the N₂ MFC flow will show 0 L/min.

The screenshot shows the Advanced View interface with a table of controller outputs and a summary row at the bottom. The table has columns for Mode, PV, User Request, Output, and Alert. The rows are: Agitation (Off, 0.0 RPM, ---, 0.0%), Temperature (Auto, 22.3 °C, 37.0 °C, 0.0%, INTERLOCK), Dissolved Oxygen (Off, -10.0%, ---, O2: 0.0%, N2: 0.0%, ERROR), pH (Off, 7.13, ---, BASE: 0.00%, CO2: 0.0%), Main Gas (Man, ---, 0.30 LPM, 0.00 LPM), Filter Oven (Auto, 38.7 °C, 38.0 °C, 0.0%), and Level (---, 2.48 L, ---, ---). The bottom row shows Gas Flow (L/Min) for Air: 0.00, N2: 0.00, CO2: 0.00, and O2: 0.00.

	Mode	PV	User Request	Output	Alert
Agitation	Off	0.0 RPM	---	0.0%	
Temperature	Auto	22.3 °C	37.0 °C	0.0%	INTERLOCK
Dissolved Oxygen	Off	-10.0%	---	O2: 0.0% N2: 0.0%	ERROR
pH	Off	7.13	---	BASE: 0.00% CO2: 0.0%	
Main Gas	Man	---	0.30 LPM	0.00 LPM	
Filter Oven	Auto	38.7 °C	38.0 °C	0.0%	
Level	---	2.48 L	---	---	
Gas Flow (L/Min)	Air: 0.00	N2: 0.00	CO2: 0.00	O2: 0.00	

Shutdown

Users can shut down the HMI computer from the Hello UI. Note that the RIO controller will continue running as long as the PBS-3 SUS has power. Because there is no “On” switch on the PBS-3 SUS, it is recommended that the HMI is only shut down after turning off all controllers, and when the PBS-3 SUS is going to be unplugged and stored.

After performing a clean shutdown, the HMI can be restarted by reconnecting power to the bioreactor.

The following power-off procedure **MUST** be used when removing power:

1. Initiate Shutdown from the Power menu in the Hello UI. If the Hello UI is not running, shutdown can be initiated from the Start Menu instead.

2. Wait for the software to shutdown and display “No Signal” (or similar) on the monitor.
3. Wait an additional 10 seconds (or longer).
4. Unplug the power cord.

NOTICE Unplugging the bioreactor without following the correct power-off procedure risks corrupting files that are critical for bioreactor system operation, including loss of historical data and user account information.

Alarms

To acknowledge alarms:

1. Navigate to the “Alarms” tab.
2. If you would like to acknowledge one alarm:

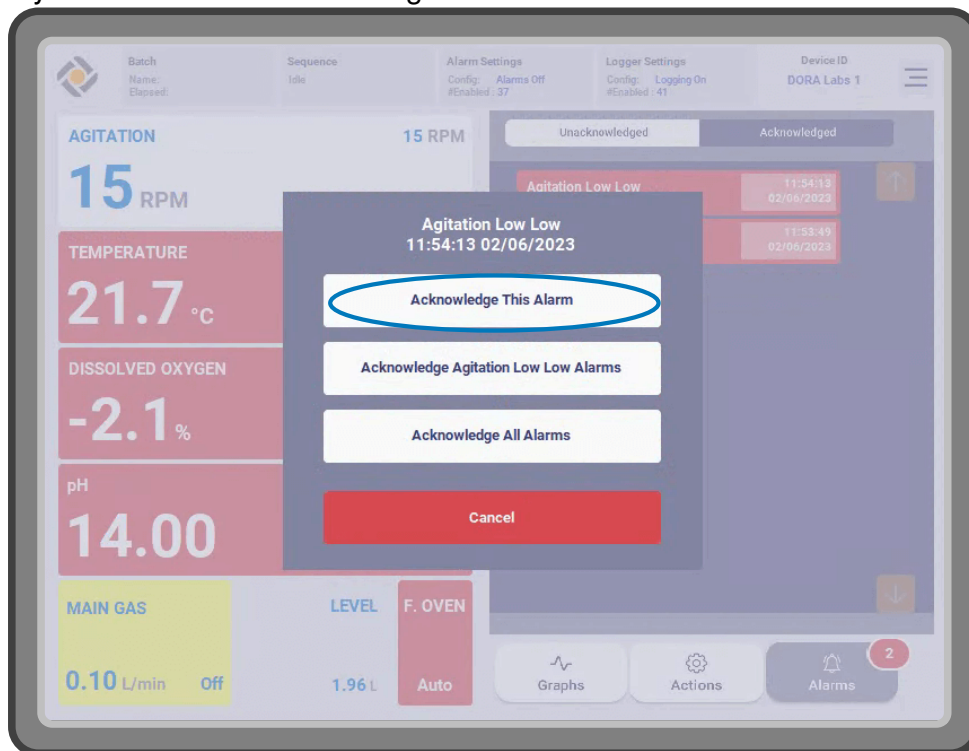

- (a) Click the alarm.
- (b) Click “Acknowledge This Alarm.”
- (c) The alarm disappears from the “Unacknowledged” list and appears in the “Acknowledged” list. The alarm now also includes which user acknowledged it and when.

3. If you would like to acknowledge all alarms of one type:

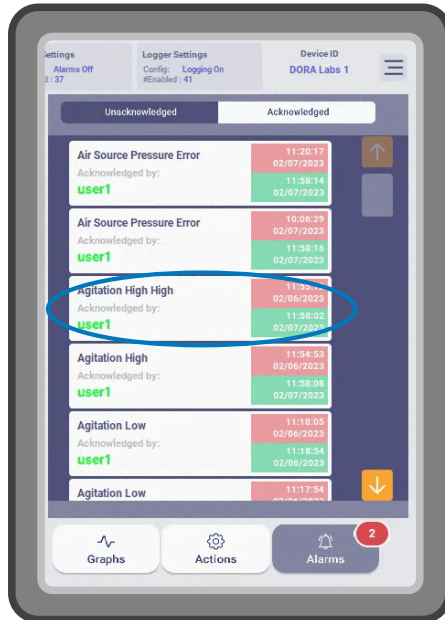

- (a) Click one alarm of that type.
- (b) Click “Acknowledge <Alarm Name> Alarms.”
- (c) All alarms of that type disappear from the “Unacknowledged” list and appear in the “Acknowledged” list. The alarms now also include which user acknowledged them and when.

4. If you would like to acknowledge all alarms:

- (a) Click any alarm.
- (b) Click “Acknowledge All Alarms.”
- (c) All alarms disappear from the “Unacknowledged” list and appear in the “Acknowledged” list. The alarms now also include which user acknowledged them and when.

For definitions of all alarms, see Appendix 2 on page 202.

Settings/System Variables

WARNING! There are many settings PBS Biotech Technical Support does not recommend users change. For a complete list of all settings, their definitions, and whether PBS Biotech Technical Support recommends changing them, see Appendix 1 on page 178.

To change settings:

1. Log in to the Hello UI as a user with the “System Variables Editor” and “Activate System Variables” permissions. The “System Variables Editor” permission allows the user to create, modify, and delete System Variables files, whereas the “Activate System Variables” permission allows the user to make a particular System Variables file active.

2. Click the triple bar ≡ (top right corner) and then “Settings.”

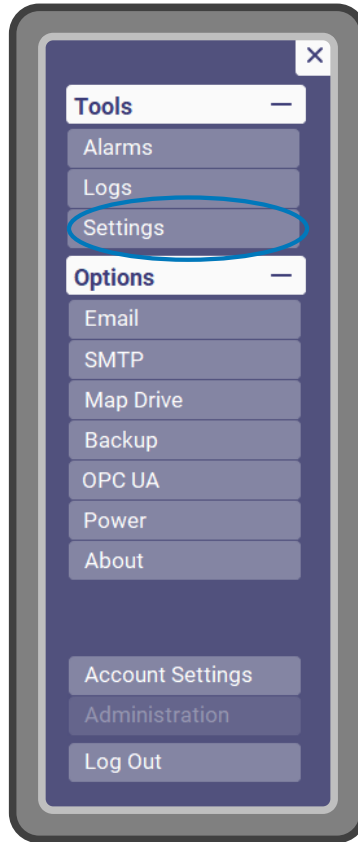

3. Click “New” if you would like to create an entirely new System Variables file. Select an existing file to duplicate, delete, rename, or edit it. You cannot delete or rename the active System Variables file. You can create multiple system variables configuration files and give them different names.

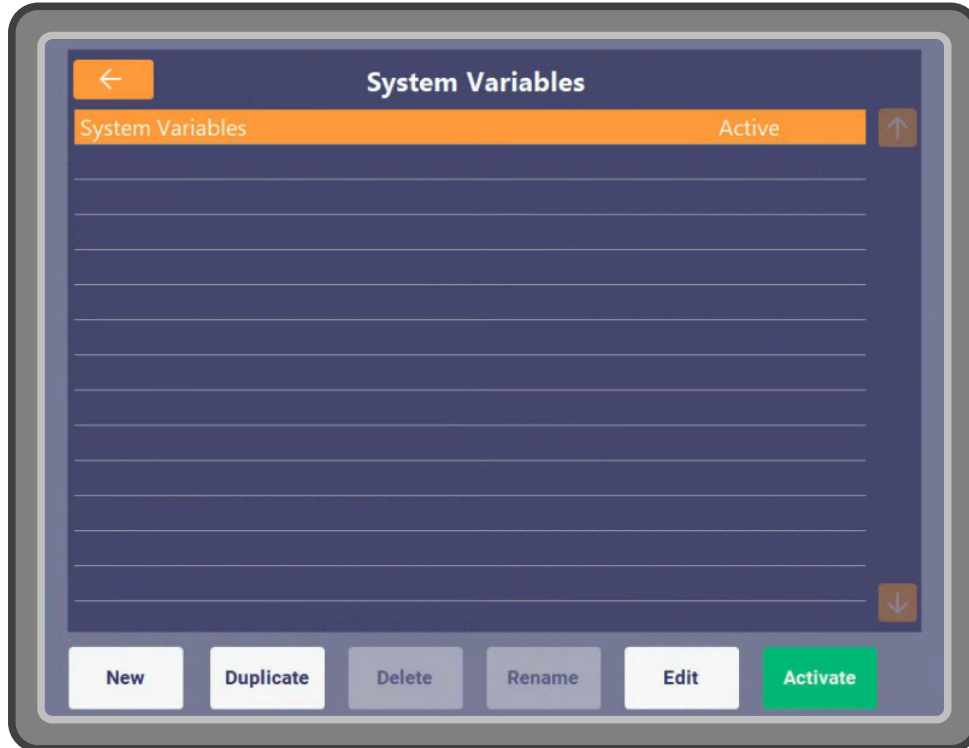

- The screen will display the variable name, the value, and the group the variable belongs to.

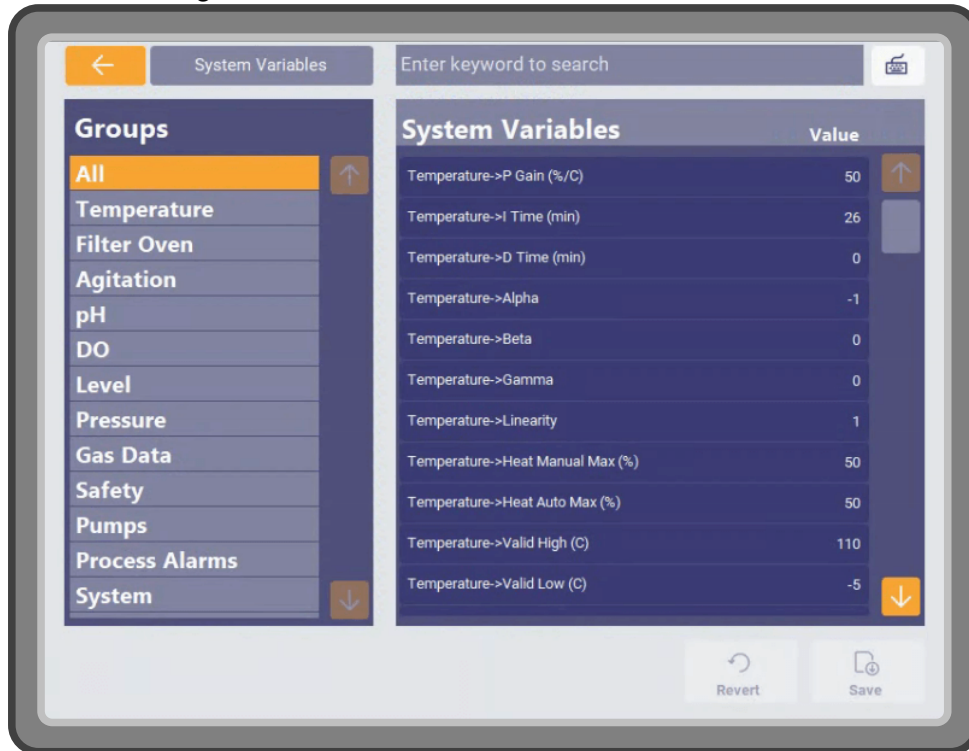

- To change the value of a variable, click the number field next to the corresponding variable and enter the desired value using the on-screen keypad or an external keyboard.
- If you wish to reverse changes you have made, click “Revert” and the file will revert back to its original values.
- When you are finished making your desired changes, click “Save.” Click the arrow in the top left corner to return to the main System Variables menu.
- Click “Activate” to make the selected file active on the RIO.

Sparging Oxygen

For processes with high O₂ consumption rates, the O₂ transfer only through the overlay may not be enough at some point in the run. Switch to sparging O₂ when the DO controller is requesting the maximum possible O₂ flow, but the DO value is still less than the set point. To switch from flowing O₂ through the overlay to sparging:

1. Set the DO control to 'Off.'
2. Disconnect the O₂ overlay line on the vessel from the O₂ overlay/O₂ sparge connector on the PBS-3 SUS.
3. Connect the O₂ sparge line on the vessel to the O₂ overlay/O₂ sparge connector on the PBS-3 SUS.
4. Set the DO control back to 'Auto' or 'Manual.'

Reboot RIO

Users should not have to reboot the RIO under normal circumstances. However, if advised to do so by PBS Biotech Technical Support or as a troubleshooting measure, the following steps should be performed:

1. Note the modes all controllers are in. For controllers in Auto mode, note the controller outputs.
2. Set all controllers to Off mode.
3. Log in to the Hello UI as a user with the "System Management" permission.

4. Click the triple bar ≡ (top right corner) and then “Power.”

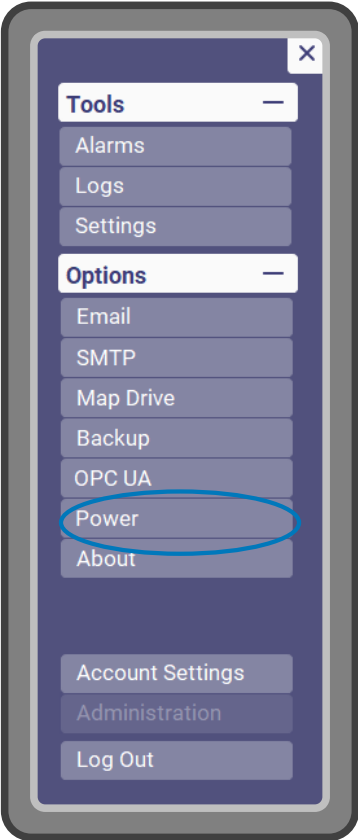

5. Click the “Reboot” button under “RIO ACTIONS,” then click “Confirm”

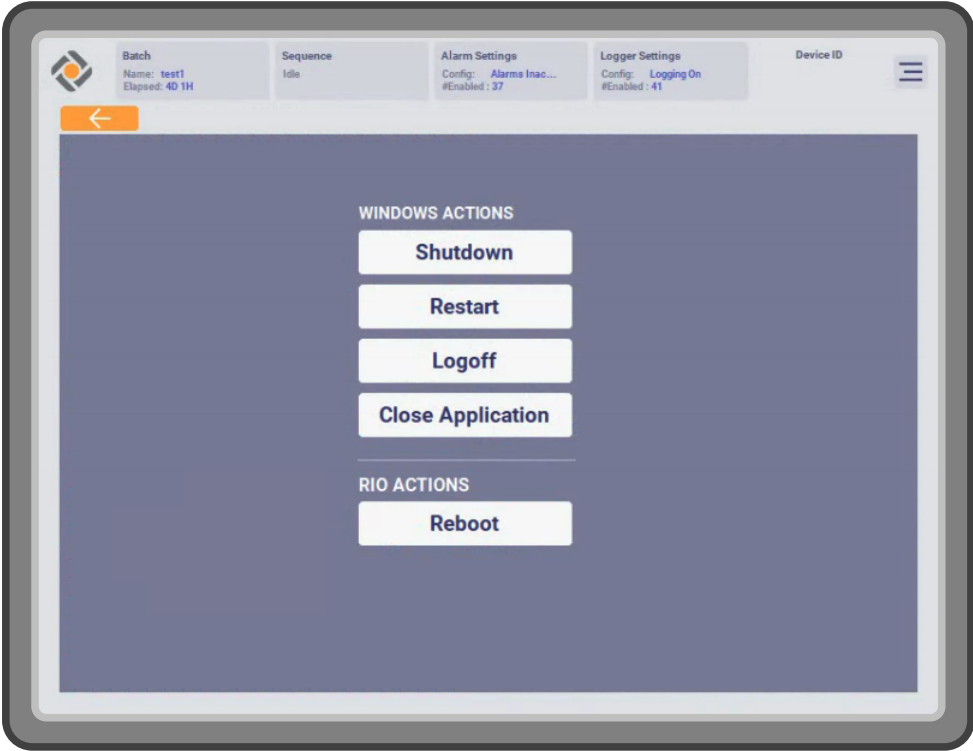

6. Wait for the RIO to finish rebooting (the “Reboot” button will no longer be grayed out).
7. When the RIO has finished rebooting, set all controllers which had been in Manual mode back to Manual mode. Set all controllers which had been in Auto mode to Manual mode, with the manual set point equal to the controller outputs noted in step 1.
8. Set all controllers which had been in Auto mode back to Auto mode.

Note: The controllers should be set to Manual mode before switching back to Auto to avoid the time lag in ramping up output.

Other Calibrations

The calibrations which users will have to perform before and during a batch run are described, with instructions, in the sections under “Before Starting a Batch Run” on page 69, and “Starting a Run” on page 83. They require the “Process Calibration” permission. Additional calibrations can be performed using the “Equipment Calibration” permission, but such calibrations should only be performed after consulting with PBS Biotech Technical Support. For more information on calibrations, see “Calibrating/Configuring Sensors” on page 145.

Hello User Interface

The software interface of the PBS-3 SUS is the Hello User Interface (Hello UI). It is automatically launched when the PBS-3 SUS is turned on.

Interlocks

To prevent unsafe conditions or conditions that would hinder the growth of cells, the software interlocks the controllers when certain conditions are met.

Conditions Causing Interlocks					
Interlocked Controls		Agitation	Temperature	Level	Main Gas
	Temperature	Agitation PV = 0 RPM and power output to the motor < "Min Ag Power (%)"	Temperature PV > "Max Temp (C)"	Level PV < "Min Level (L)" or Level PV > "Max Level (L)"	
	Filter Oven		Temperature PV < 32 °C and Main Gas is Off		Main Gas is Off and Temperature PV < 32 °C
	pH			Level PV > "Max Level (L)"	
	Control Pumps			Level PV > "Max Level (L)"	

Agitation

The agitation PV is determined by a Hall effect sensor which detects the passage of magnets on the Vertical-Wheel® impeller. The period between magnet passes is used to calculate a value in RPM. The calculation is averaged over a configurable number of samples to report an accurate, stable value.

The Vertical-Wheel® impeller is magnetically coupled to a motor in the bioreactor which controls agitation output.

The agitation controller has three user modes and one sensor error mode:

- Off mode
- Manual mode
- Auto mode
- Lookup mode (sensor error mode)

Off Mode

No power is supplied to the motor.

Manual Mode

User selects a power output as a percentage of the motor's maximum.

Auto Mode

User selects a set point in units of RPM. A PID controller adjusts the motor's power output to achieve a stable set point.

Lookup Mode

This is the agitation sensor error mode. Lookup mode is triggered if too much time has passed in Auto Mode since the last magnet pass was detected. The controller assumes that the sensor has failed, and attempts to estimate the output required to achieve the set point.

The timeout can be adjusted by changing the "Lookup Mode Timeout (s)" setting. The power output estimation is calculated as: $\text{Set Point} \times \text{Lookup Factor (\%/RPM)}$.

Output Ranges

For agitation control range, see "Agitation Control Range" on page 36.

Agitation motor power range is 0 - 100%.

Relevant Settings

See Appendix 1 on page 178 for each setting's default value, definition, and whether users can safely change the value without consulting PBS Biotech Technical Support.

Agitation (page 181)

- P Gain (%/RPM)
- I Time (min)
- D Time (min)
- Alpha
- Beta
- Gamma
- Linearity
- Minimum (RPM)
- Lookup Mode Timeout (s)
- Lookup Factor (%/RPM)
- Power Auto Max (%)
- Power Auto Min (%)
- Auto Max Startup (%)
- Power Manual Max (%)
- Number of Magnets
- Samples to Average

Safety (page 196)

- Min Ag Power (%)

Process Alarms (page 198)

- Agitation Low Low (RPM)
- Agitation Low (RPM)
- Agitation High (RPM)
- Agitation High High (RPM)

Interlocks

The PBS-3 SUS has no interlocks that prevent power output from the agitation motor.

Temperature

The temperature PV, reported in degrees celsius ($^{\circ}\text{C}$), is determined by the built-in temperature sensor, which is inserted in the vessel's thermal well. The software refers to it as "temperature sensor A."

The temperature controller has three user modes and one sensor error mode:

- Off mode
- Manual mode
- Auto mode
- Sensor error mode

Off Mode

The main heater is off.

Manual Mode

User selects a main heater duty as a percentage of its maximum power.

Auto Mode

User selects a set point in $^{\circ}\text{C}$. A PID controller adjusts the main heater duty to attempt to achieve the set point.

Sensor Error Mode

When temperature is in Auto mode and the temperature sensor detects a PV outside the valid range, the software assumes the sensor is experiencing an error condition, and in its best attempt at maintaining control the software outputs the average of its output values during the last 100 seconds before the software entered sensor error mode.

Output Ranges

For temperature control range, see “Temperature Control Range” on page 36.

The recommended main heater duty output range is 0 – 50%.

Relevant Settings

See Appendix 1 on page 178 for each setting’s default value, definition, and whether users can safely change the value without consulting PBS Biotech Technical Support.

Temperature (page 178)

- P Gain (%/C)
- I Time (min)
- D Time (min)
- Alpha
- Beta
- Gamma
- Linearity
- Heat Manual Max (%)
- Heat Auto Max (%)
- Valid High (C)
- Valid Low (C)

Safety (page 196)

- Min Ag Power (%)
- Max Temp (C)
- Min Level (L)
- Max Level (L)

Process Alarms (page 198)

- Temp Low Low (C)
- Temp Low (C)
- Temp High (C)
- Temp High High (C)

Interlocks

The main heater will not turn on if the agitation PV is below the Agitation “Minimum (RPM)” setting unless the power output to the agitation motor is greater than the Safety “Min Ag Power (%)” setting. This is to avoid overheating cells which settle at the bottom of the vessel. The main heater will continue to heat as long as the agitation controller is outputting sufficient power, even if the Hall effect sensor fails.

The main heater will not turn on if the temperature PV is greater than or equal to the Safety “Max Temp (C)” setting. This protects the run against a sensor error or an improperly entered set point.

The main heater will not turn on if the level PV is below the Safety “Min Level (L)” setting. This prevents damage to the disposable or its contents when the bioreactor system cannot properly control temperature at low volumes.

The main heater will not turn on if the level PV is above the Safety “Max Level (L)” setting. This is to prevent the heater from burning any medium which would spill out of an overfull vessel.

Main Gas

The main gas PV, reported in liters per minute (LPM), is determined by reading the feedback voltages from the four gas mass flow controllers (MFCs): Air, N₂, O₂, and CO₂. Main gas only has two modes: Off, where no gas flows, and Manual, where the gas flows at the rate requested by the user.

The gas flow rate ranges for the MFCs are defined in “Gas Flow Rate Range” on page 36. If the requested flow rate for an individual gas is less than the MFC’s minimum flow rate, the MFC will “pulse” its output to meet the request. The software prioritizes the gas composition to meet the pH and DO controller requests in the following order:

1. CO₂
2. O₂
3. N₂
4. Air (remainder of request)

Relevant Settings

See Appendix 1 on page 178 for each setting’s default value, definition, and whether users can safely change the value without consulting PBS Biotech Technical Support.

Gas Data (page 193)

- CO₂ Min (LPM)
- CO₂ Off (V)
- N₂ Min (LPM)
- N₂ Off (V)
- Air Min (LPM)
- Air Off (V)
- O₂ Min (LPM)
- O₂ Off (V)
- PWM On Time (s)
- PWM Max Period (s)
- Mismatch Thresh (V)
- Manual Max (LPM)

Process Alarms (page 198)

- Main Gas Low Low (LPM)
- Main Gas Low (LPM)
- Main Gas High (LPM)
- Main Gas High High (LPM)

Interlocks

There are no interlocks preventing main gas flow in the PBS-3 SUS.

Dissolved Oxygen

The dissolved oxygen PV is reported as a percent of Air Saturation [(%) or (DO%)] and is determined by a DO sensor. The software refers to it as “DO sensor A.” A measurement of 100% DO does not mean the media is fully saturated with Oxygen, but instead that the media is fully saturated with Air. Because the DO sensor is fluorometric, shining a bright light directly onto the DO sensor spot can affect the DO PV.

The DO is controlled by varying the N₂ and O₂ gas flow as a percentage of main gas flow. The DO PV is lowered by increasing the % N₂ composition, and is raised by increasing the % O₂ composition. To understand how the software determines which gases to flow, see “Main Gas” on page 134.

The DO controller has three user modes and one sensor error mode:

- Off mode
- Manual mode
- Auto mode
- Sensor error mode

Off Mode

N₂ and O₂ are 0% of main gas flow.

Manual Mode

User selects N₂ and/or O₂ flow as a percentage of main gas flow.

Auto Mode

User selects a set point in units of % dissolved oxygen, which the software achieves by adjusting N₂ flow and O₂ flow. Each gas uses its own PID loop: the N₂ loop controls to the DO set point plus the DO “Deadband (DO%)” setting, and the O₂ loop controls to the DO set point minus the DO “Deadband (DO%)” setting.

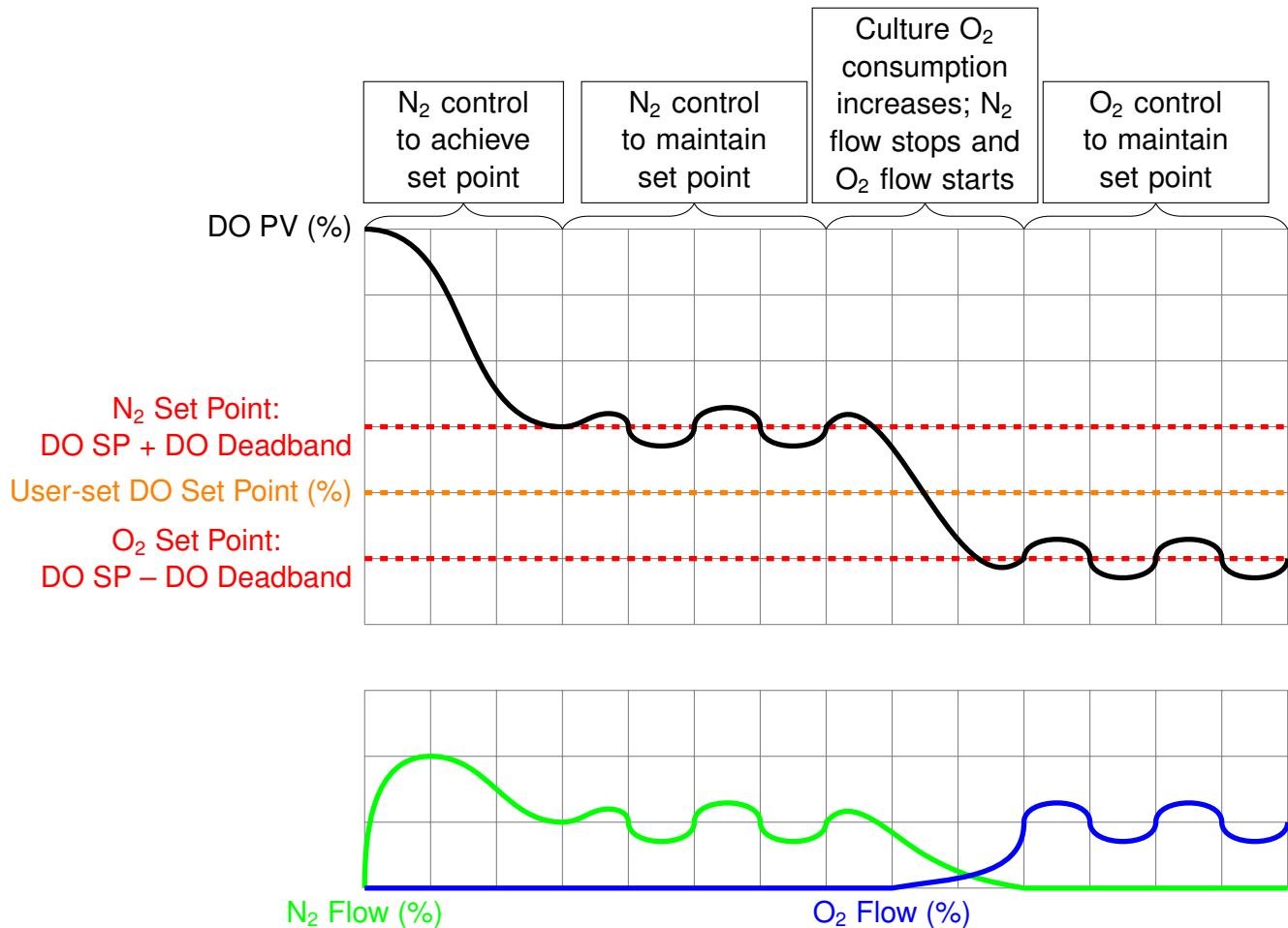

Sensor Error Mode

When DO is in Auto mode and the DO sensor detects a PV outside the valid range, the software assumes the sensor is experiencing an error condition, and outputs the average of its N₂ and O₂ output values during the last 100 seconds before the software entered sensor error mode. Note that this is only intended to preserve short term stability – users should still take appropriate action in the event of sensor failure.

Output Ranges

The recommended N₂ output is 0 - 100% of main gas flow. The N₂ MFC output is stated in “Gas Flow Rate Range” on page 36. N₂ “pulsing” at the minimum value takes effect if the N₂ % called for represents less than the MFC’s minimum flow rate.

The O₂ MFC output is stated in “Gas Flow Rate Range” on page 36. O₂ “pulsing” at the minimum value takes effect if the O₂ % called for represents less than the MFC’s minimum flow rate. The software will not request more than the O₂ MFC minimum flow until the net volume of O₂ output since turning DO on is greater than the Gas Data “O₂ Min Volume (L)” setting. This is known as the “O₂ Slow Start” feature, and is intended to prevent damage to the vessel or accessories when O₂ is being sparged.

Relevant Settings

See Appendix 1 on page 178 for each setting’s default value, definition, and whether users can safely change the value without consulting PBS Biotech Technical Support.

DO (page 188)

- Valid High (DO%)
- Valid Low (DO%)
- O₂ P Gain (%/DO%)
- O₂ I Time (min)
- O₂ D Time (min)
- O₂ Alpha
- O₂ Beta
- O₂ Gamma
- O₂ Linearity
- O₂ Manual Max (%)
- O₂ Auto Max (%)
- N₂ P Gain (%/DO%)
- N₂ I Time (min)
- N₂ D Time (min)
- N₂ Alpha
- N₂ Beta
- N₂ Gamma
- N₂ Linearity
- N₂ Manual Max (%)
- N₂ Auto Max (%)
- Deadband (DO%)

Gas Data (page 193)

- N₂ Min (LPM)
- N₂ Off (V)
- O₂ Min (LPM)
- O₂ Off (V)
- PWM On Time (s)
- PWM Max Period (s)
- Mismatch Thresh (V)
- O₂ Min Volume (L)

Process Alarms (page 198)

- DO Low Low (%)
- DO Low (%)
- DO High (%)
- DO High High (%)

Interlocks

The PBS-3 SUS has no interlocks that prevent N₂ or O₂ flow.

pH

The pH PV is determined by a pH sensor. The sensor head uses internal temperature compensation to provide more accurate pH readings. The software refers to it as “pH sensor A.”

The pH is controlled by varying the CO₂ flow in % composition of main gas flow and varying the percent of time the base pump is on. Increasing CO₂ flow decreases pH PV, and increasing base pump duty increases pH PV. To understand how the software determines which gases to flow, see “Main Gas” on page 134.

Before inoculating (i.e. when there is no metabolic activity), the pH has a predictable relationship with the concentration of sodium bicarbonate (NaHCO₃) in the medium and the % CO₂ composition. Below the following chart is the equation to calculate the resulting pH from a known concentration of sodium bicarbonate and a known % CO₂ composition. However, the following chart can be simpler to use.

To find the pH that would result from a known concentration of sodium bicarbonate and a known % CO₂ composition, draw a straight line between the points on the sodium bicarbonate and CO₂ axes. The line will cross the pH axis at the pH value. In fact, the chart can be used to find the third variable if any of the other two are known.

For example, if the medium being used has a sodium bicarbonate concentration of 3.7 g/L and the desired pH is 7.4, draw a straight line between those points on the corresponding axes, and extend the line to the CO₂ axis. You can see that a % CO₂ composition of just over 9% will result in the desired pH.

You can also see that to get the same pH using sodium bicarbonate concentrations of 2.2 g/L and 1.5 g/L will require % CO₂ compositions of about 5.5% and 3.5%, respectively.

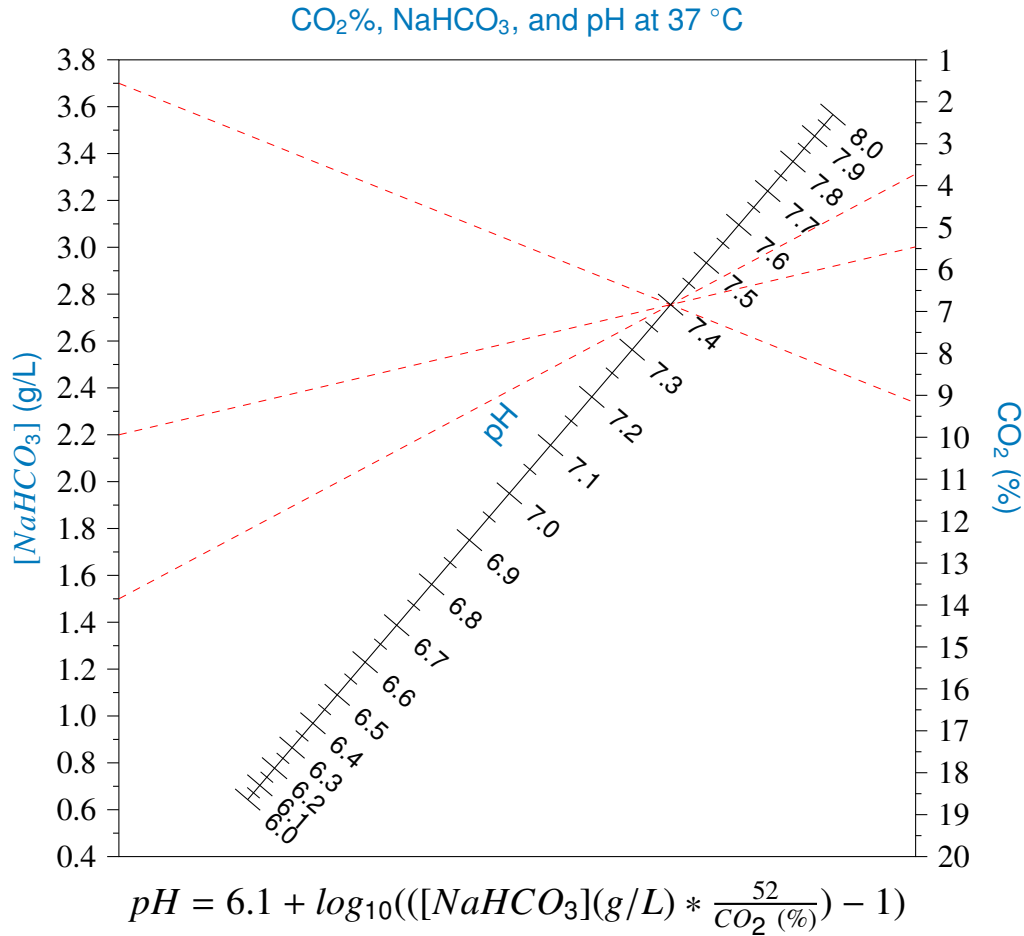

The pH controller has three user modes and one sensor error mode:

- Off mode
- Manual mode
- Auto mode
- Sensor error mode

Off Mode

CO₂ is 0% of main gas flow and base pump duty is 0%.

Manual Mode

User selects a CO₂ flow in % composition of main gas flow, and/or a base pump duty in % (the user must select the base pump as well).

Auto Mode

User selects a set point in pH units. If it will be necessary to use base, the user also selects a base pump. The software achieves the set point by adjusting CO₂ flow and base pump duty. Each has its own PID loop: while both the CO₂ loop and the base loop control to the pH set point, the CO₂ will only output if the pH PV is greater than the pH set point plus the pH “Deadband” setting, and the base will only output if the pH PV is less than the pH set point minus the pH “Deadband” setting.

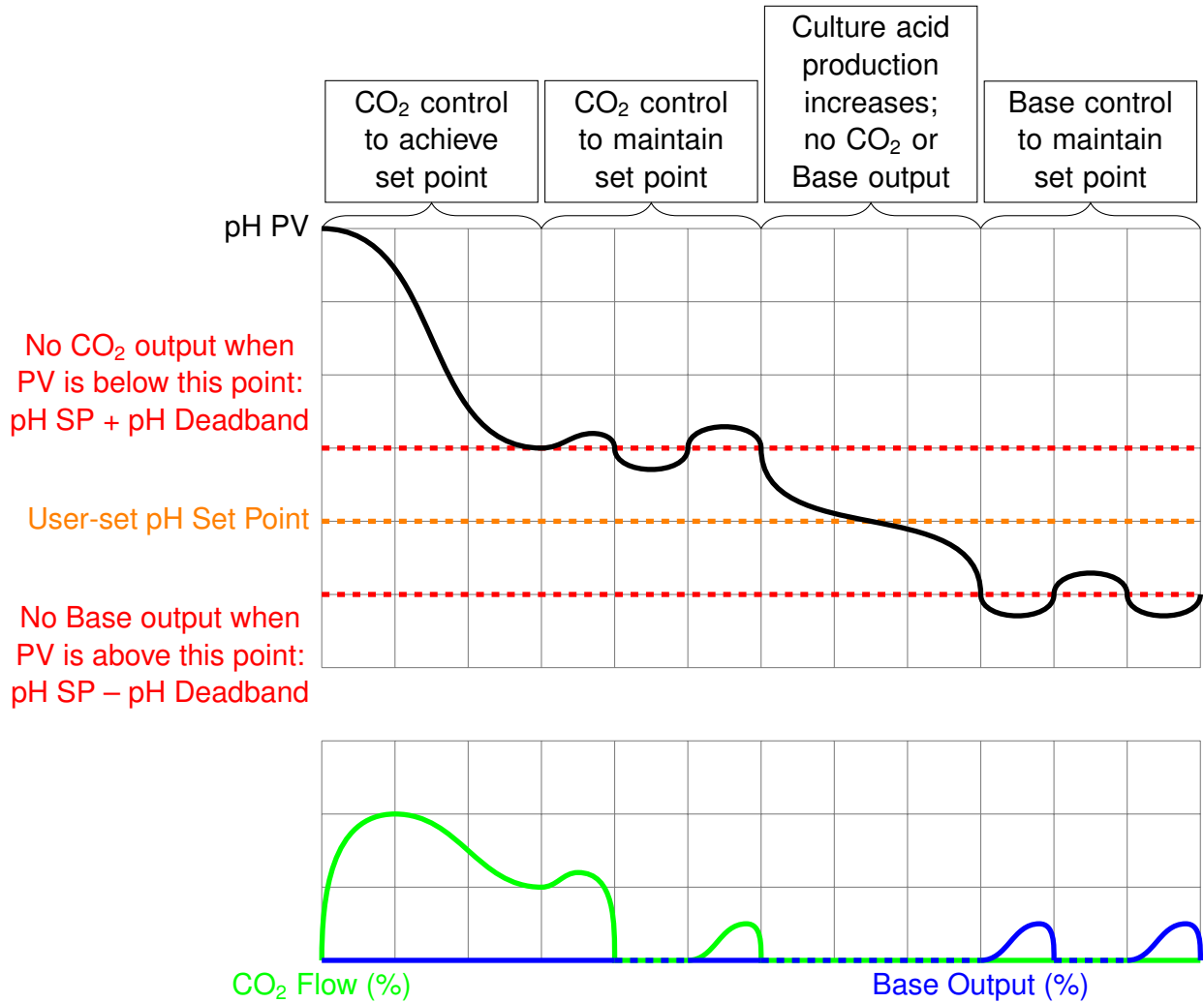

Sensor Error Mode

When pH is in Auto mode and the pH sensor detects a PV outside the valid range, or the PV has changed by more than the “Rate Fail Delta PV” in the time “Rate Fail Delta Time (s),” the software assumes the sensor is experiencing an error condition, and outputs the average of its CO₂ and base pump output

values during the last 100 seconds before the software entered sensor error mode. Note that this is only intended to preserve short term stability – users should still take appropriate action in the event of sensor failure.

Output Ranges

The recommended CO₂ output is 0 - 100% CO₂ composition of main gas flow. The CO₂ MFC output is stated in “Gas Flow Rate Range” on page 36. CO₂ “pulsing” at the minimum value takes effect if the CO₂ % called for represents less than the MFC minimum flow rate.

The base pump output is technically 0 - 100% duty, however PBS Biotech Technical Support recommends using a range only up to your expected base consumption.

Relevant Settings

See Appendix 1 on page 178 for each setting’s default value, definition, and whether users can safely change the value without consulting PBS Biotech Technical Support.

pH (page 183)

- Rate Fail Delta PV
- Rate Fail Delta Time (s)
- CO₂ P Gain (%/pH)
- CO₂ I Time (min)
- CO₂ D Time (min)
- CO₂ Alpha
- CO₂ Beta
- CO₂ Gamma
- CO₂ Linearity
- CO₂ Manual Max (%)
- CO₂ Auto Max (%)
- Base P Gain (%/pH)
- Base I Time (min)
- Base D Time (min)
- Base Alpha
- Base Beta
- Base Gamma
- Base Linearity
- Base Manual Max (%)
- Base Auto Max (%)
- Base Wait Time (s)
- A Use Temp Comp?
- Deadband
- Valid High (pH)
- Valid Low (pH)

Gas Data (page 193)

- CO₂ Min (LPM)
- CO₂ Off (V)
- PWM On Time (s)
- PWM Max Period (s)
- Mismatch Thresh (V)

Safety (page 196)

- Max Level (L)

Pumps (page 198)

- Base On Time (s)
- Base Max Period (s)

Process Alarms (page 198)

- pH Low Low
- pH Low
- pH High
- pH High High

Interlocks

The base pump will not turn on if the level PV is above the “Max Level (L).” This prevents base from being added to the point of overflowing the vessel.

The PBS-3 SUS has no interlocks that prevent CO₂ flow.

Level Sensing

The vessel rests on a load cell in the vessel sleeve. The weight the load cell detects is displayed as the level PV in the software.

For the level sensor to work properly, the user must perform a ‘zero’ calibration at 0 L with an empty vessel, with all tubing and sensors configured as they will be during use. After filling the vessel with medium, before turning any controls on, the user should perform a ‘span’ calibration if the Level reading reported by the software is significantly different from the actual volume in the vessel.

The working level range of the PBS-3 SUS is 1.8 – 3 L. Below the minimum, the Vertical-Wheel[®] impeller is not fully covered and may not function optimally, but certain processing steps may be performed with volumes as low as 0.6 L. Above the maximum there is the danger of overflowing the vessel, causing overflow.

Relevant Settings

See Appendix 1 on page 178 for each setting’s default value, definition, and whether users can safely change the value without consulting PBS Biotech Technical Support.

Level (page 192)

- Empty Level (V)
- Empty Level (L)
- Enable Sensor (0 or 1)
- CalLevelSlopeMax(psi/V)
- CalLevelSlopeMin(psi/V)
- CalLevelInterceptMax(psi)
- CalLevelInterceptMin(psi)

Safety (page 196)

- Min Level (L)
- Max Level (L)

Process Alarms (page 198)

- Level Low Low (L)
- Level Low (L)
- Level High (L)
- Level High High (L)

Filter Oven

The filter oven keeps the exhaust filter at an elevated temperature to reduce moisture accumulation in the exhaust filter. The factory default is 38 °C.

The filter oven's temperature PV is determined by a temperature sensor positioned inside the filter oven.

NOTICE If operators insist on setting the filter oven to Off when the PBS-3 SUS is not in use, they need to be very careful to ensure they have set it to Auto mode when using the PBS-3 SUS. Because of the way the filter oven interlock works (see below), it is actually not necessary nor recommended to ever set the filter oven to Off mode.

Off Mode

The filter oven heater is off.

Manual Mode

User selects a filter oven heater duty as a percentage of its maximum power.

Auto Mode

User selects a set point in °C. A PID controller varies the filter oven heater duty to attempt to achieve the set point.

Sensor Error Mode

When filter oven is in Auto mode and the filter oven temperature sensor detects a PV outside the valid temperature range, the software assumes the sensor is experiencing an error condition, and outputs the average of its output values during the last 100 seconds before the software entered sensor error mode. Note that this is only intended to preserve short term stability – users should still take appropriate action in the event of sensor failure.

Output Ranges

The filter oven heater duty range is 0 - 100%.

Relevant Settings

See Appendix 1 on page 178 for each setting's default value, definition, and whether users can safely change the value without consulting PBS Biotech Technical Support.

Temperature (page 178)

- Valid High (C)
- Valid Low (C)

Filter Oven (page 179)

- P Gain (%/C)
- I Time (min)
- D Time (min)
- Alpha
- Beta
- Gamma
- Linearity
- Heat Manual Max (%)
- Heat Auto Max (%)

Process Alarms (page 198)

- Filter Oven Low Low (C)
- Filter Oven Low (C)
- Filter Oven High (C)
- Filter Oven High High (C)

Interlocks

The filter oven heater will not turn on if the main temperature PV is below 30 °C and no gas flow is requested. This is why it is recommended to operators to always leave filter oven in Auto mode - then, the filter oven will only turn on if necessary. If the main temperature PV is greater than or equal to 30 °C, or gas is flowing, there is a risk of the exhaust filter getting clogged, unless the filter oven is on.

Control Pumps

Types (Media and Additions A and B)

The media pump is meant to be used for initially filling the vessel with medium and to empty the vessel when it is time to harvest.

The additions pumps are meant to be used throughout the run, for slow, medium, or fast titrations or quick one-time additions. Their pump speeds are adjustable. It is also an addition pump that the user must choose as the base pump if they desire base control – neither addition pump is automatically selected.

Relevant Settings

See Appendix 1 on page 178 for each setting's default value, definition, and whether users can safely change the value without consulting PBS Biotech Technical Support.

Level (page 192)

- Enable Sensor (0 or 1)

Safety (page 196)

- Max Level (L)

Pumps (page 198)

- Aux Low Duty
- Aux Med Duty
- Base On Time (s)
- Base Max Period

Interlocks

The media and addition pumps will not turn on if the level PV is greater than the “Max Level (L).” This prevents medium or additions being added to the point of overflowing the vessel.

To empty the vessel when the level PV is above the “Max Level (L),” increase the value of the setting, empty the vessel using the harvest line and medium pump, and restore the “Max Level (L)” setting to its original value.

Main Light

The PBS-3 SUS has a white LED light to illuminate the contents of the vessel. It can be turned on and off through the software. This light source does not impact the DO sensor spot and therefore the DO PV, but other sources of light might and therefore operators should use caution when using other light sources.

Calibrating/Configuring Sensors

Pre-Calibration Medium Conditioning Strategy

After adding cell culture medium but before inoculating with cells, the DO and pH sensors must be calibrated. This is because every sensor is unique, and the calibration values for the sensors used with the last vessel will not be ideal for the current sensors. Before the DO and pH sensors are calibrated, their reported measurements should not be considered accurate or reliable. In order to calibrate these sensors, the cell culture medium first needs to be conditioned, and the reported sensor PVs need to equilibrate. The controls

should be set so the medium is in the ideal condition for the cells being cultured.

One reason for this is that if the medium is already in the ideal condition for the cells being cultured, the operators will not have to wait any time between calibrating the DO and pH sensors and inoculating with the cells. For example, if the operator were to set pH in Auto mode before calibrating, with a set point of pH=7.4, the software will adjust the percent of CO₂ in the headspace until the pH sensor reports a measurement of 7.4. However, because the sensor has not been calibrated yet, and individual sensors vary (which is why calibrating them is necessary), the actual pH of the media in the vessel is very unlikely to be 7.4. If it is actually 7.5 or 7.3, for example, then after performing a calibration, the operator will have to wait to inoculate until the software adjusts the percent of CO₂ in the headspace and the pH sensor again reports a measurement of 7.4. Otherwise the bioreactor wouldn't be an optimal environment for the cells. But if the operator knew that the cell culture medium will have a pH of 7.4 from running 5% CO₂ in the headspace, the operator could set pH to Manual mode at 5% CO₂ to equilibrate (see the "NaHCO₃, CO₂%, and pH at 37 °C" chart on page 138 for more information). After equilibration and before calibration, it would not matter if the pH sensor reports 7.3 or 7.5, because the operator would calibrate it to be 7.4 (after verifying by taking a sample and measuring its pH). The operator could then immediately inoculate because the bioreactor would already be an optimal environment for the cells.

A second reason is that the DO and pH sensors should be calibrated to a measurement that is as close as possible to the condition the software will be controlling to during the cell culture run. This will minimize inaccuracy in the reported sensor measurement. Calibrating to a measurement which will not actually be controlled to introduces unnecessary inaccuracy in the reported sensor measurement. While the software uses a straight line $y = mx + b$ as the relationship between the sensor's raw output and the calculated PV, no sensor is 100% perfect, and there are inaccuracies. In the above example, when the operator put pH in Auto mode with a set point of 7.4 before calibrating, let's say that the actual PV was 7.3. When the operator then calibrates the pH to read 7.3, the sensor's reading at that single point has less inaccuracy than it would for any other pH PV. But because the operator intends to control the pH at 7.4 during the cell culture run via Auto mode, it would be in their best interest to manually control pH to conditions that will result in the pH being 7.4 before that first calibration. This can be accomplished by using the "NaHCO₃, CO₂%, and pH at 37 °C" chart on page 138 and setting the CO₂% by putting pH in Manual mode. Then, the operator could calibrate the pH reading to equal 7.4, and the running condition will match the PV where sensor inaccuracy has been minimized.

The agitation and main gas controls need to be on, so the contents of the vessel are mixed homogeneously, the Temperature is not interlocked, and the gases flowing through the headspace are able to efficiently diffuse into the medium. The agitation can be set to control to a higher RPM during this stage than when the bioreactor is inoculated, to speed up the process of conditioning the medium. Similarly, setting main gas flow to a higher flow rate during this stage than when the bioreactor is inoculated will also speed up the process of conditioning the medium. Or, operators could instead choose to set the main gas flow to a lower flow rate, to minimize gas use before inoculation. This may require additional time to condition the medium. The temperature control should be set to the temperature optimal for the cells. For most applications, this is 37 °C. This is important because the temperature of the medium has an effect on both the DO and pH of the medium.

It is recommended to condition the medium before these first calibrations by controlling DO and pH in Manual mode, rather than Auto mode. As explained above, this saves time and also minimizes calibration inaccuracy. Additionally, if DO is controlled in Auto mode, then the operator would be required to measure the DO of a sample to use as a reference when performing the calibration. For both pH and DO, regardless of whether the controller is in Auto or Manual mode, care must be taken when taking the sample and measuring it to ensure accuracy, as off-gassing can result in the sample's gas composition changing to be different from that of the medium. This is especially difficult to avoid for the DO. For more information, see "Take Sample" on page 156. This off-gassing can lead to the measurement of the sample not being accurate, and calibrations being performed to inaccurate or non-representative reference measurements can result in the calibrated sensor measurements being less accurate.

While it is technically possible to use DO and/or pH in Auto mode when conditioning the medium before performing the 'span'/'one-point' calibrations, it is not recommended for the reasons explained above. Before inoculation, the gas composition of the headspace has a reliable and predictable effect on the gas composition of the medium. This means that putting DO and pH in Manual mode allows the operator to directly control the actual DO and pH of the medium. This allows the operator to use a very reliable and accurate reference when performing the 'span'/'one-point' calibrations after the medium is conditioned and the sensor readings equilibrate.

Which Sensors Can Be Calibrated

It is possible to perform calibrations on the following sensors. Their calibration slope and intercept (m and b) values can also be manually entered; however, this should not be done without consulting PBS Biotech Technical Support.

Dissolved Oxygen

For a single-use DO sensor, users should perform a 'span' calibration before inoculation. It is generally not recommended that users perform additional 'span' calibrations during a run. Users should not perform any 'zero' or 'two-point' calibrations, or manually enter calibration slope and intercept (m and b) values, without consulting PBS Biotech Technical Support.

This is because before inoculating with cells, the gas composition of the headspace has a reliable and predictable effect on the actual DO of the medium, so the operator can directly control the DO by putting pH and DO in Manual mode. This is the best reference to use when calibrating the DO sensor.

After inoculating with cells, the cells' oxygen consumption additionally affects the actual DO of the medium, and so it can no longer be determined only based on the gas composition of the headspace. This means that a reference sample will have to be taken and measured, and the DO would have to be calibrated to that reference measurement. Taking the sample and handling it afterwards can introduce additional air to the sample and result in off-gassing, so the sample's gas composition no longer matches that of the media in the vessel, and the measured DO of the sample is not representative of the DO of the media in the vessel. For more information, see "Sampling for DO Measurement" on page 158. Calibrating to an inaccurate or non-representative reference measurement can result in the calibrated sensor measurements being less accurate.

Additionally, for most applications, the DO sensor drift is minimal throughout a cell culture run. If sensor drift is suspected to be an issue for a process, it needs to be confirmed by isolating as many variables as possible when taking reference samples. Contact Applications Engineering at app.eng@pbsbiotech.com for additional information. If sensor drift is confirmed to be an issue for a process, the methods of collecting a sample and measuring it need to be confirmed to change the DO of the sample as little as possible for the reference measurement to be reliable. For more information, see "Sampling for DO Measurement" on page 158.

pH

For a single-use pH sensor, users should perform a 'one-point' calibration before inoculation, and throughout a run if the measured pH of a sample shows that the sensor has drifted. Users should not perform 'two-point' calibrations or manually enter calibration slope and intercept (m and b) values without consulting PBS Biotech Technical Support.

Level

Users should perform a 'zero' calibration on an empty vessel at the beginning of a run. After filling the vessel with medium, before turning any controls on, the user should perform a 'span' calibration if the Level reading reported by the software is significantly different from the actual volume in the vessel. Level calibrations cannot be performed from the Hello UI while the agitation control is on.

Temperature

The PBS-3 SUS is shipped with its temperature sensor already calibrated. Users should not calibrate the temperature sensor without consulting PBS Biotech Technical Support.

Filter Oven Temperature

The PBS-3 SUS is shipped with its filter oven temperature sensor already calibrated. Users should not calibrate the filter oven temperature sensor without consulting PBS Biotech Technical Support.

Calibration Types

The PBS software supports multiple calibration types for each sensor. However, not all calibration types are appropriate for all sensors or all situations.

All the calibrations rely on there being a linear relationship between the sensor's raw voltage signal and the reported Present Value. This means the calibration curves take the form of

$$y = mx + b$$

where y is the final calculated Present Value (PV) (% for DO, L for Level, etc.), m is the calibration slope, x is the sensor's raw voltage signal, and b is the intercept. All calibration operations involve changing the slope and/or intercept so when the sensor reports a particular raw voltage value, the calculated Present Value is different than it would have been when the original calibration

values were in use.

In all the examples below, the calibration slope and intercept values do not correspond to the expected calibration values for any actual sensors on the PBS-3 SUS.

Zero

A 'zero' calibration involves keeping the original calibration's slope, and adjusting the intercept so the PV equals zero at the calibration condition. This requires being able to reliably create conditions where the PV for that sensor type should equal 0.

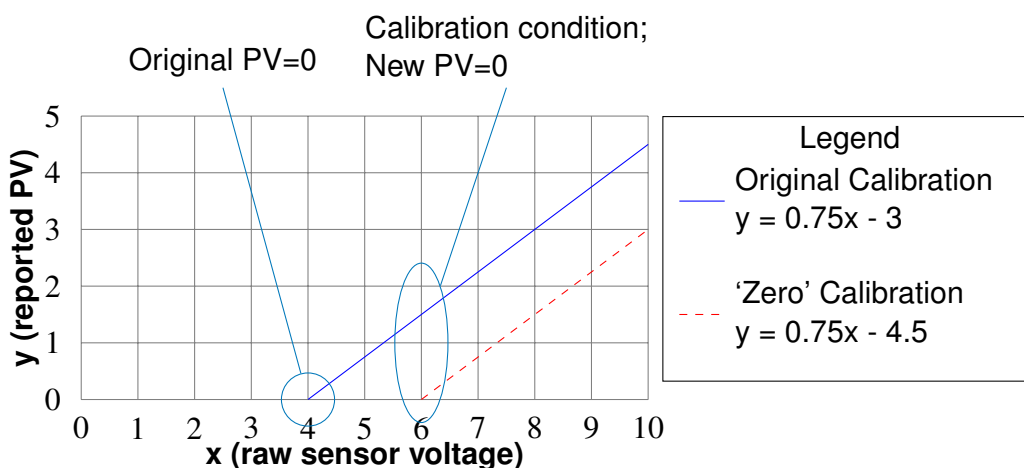

In the above example, the calibration would have been performed when the raw sensor voltage was 6. With the original calibration values, the PV would have been 1.5, but the operator knew that the actual PV should be 0 under that condition. The slope stayed at 0.75, but the intercept changed from -3 to -4.5.

This calibration type is applicable to sensors whose PV=0 condition is relevant and easily and reliably achieved:

- When an empty vessel is installed, the Level PV should be 0.
- For the DO sensor, the PV=0 condition can be achieved by exposing the single-use sensor dot to a 100% N₂ condition. This can be achieved by installing a nonsterile sensor dot in a small container. To achieve the PV=0 condition while maintaining the sterility of the sensor dot which comes installed in the vessel, flooding the vessel with N₂ is required. Note that this is a time-consuming process.

Two-point

A 'two-point' calibration involves quickly changing between two created calibration conditions, where the operator reliably knows what the PV should

be at each condition. Usually, both the slope and intercept change as a result of performing a 'two-point' calibration.

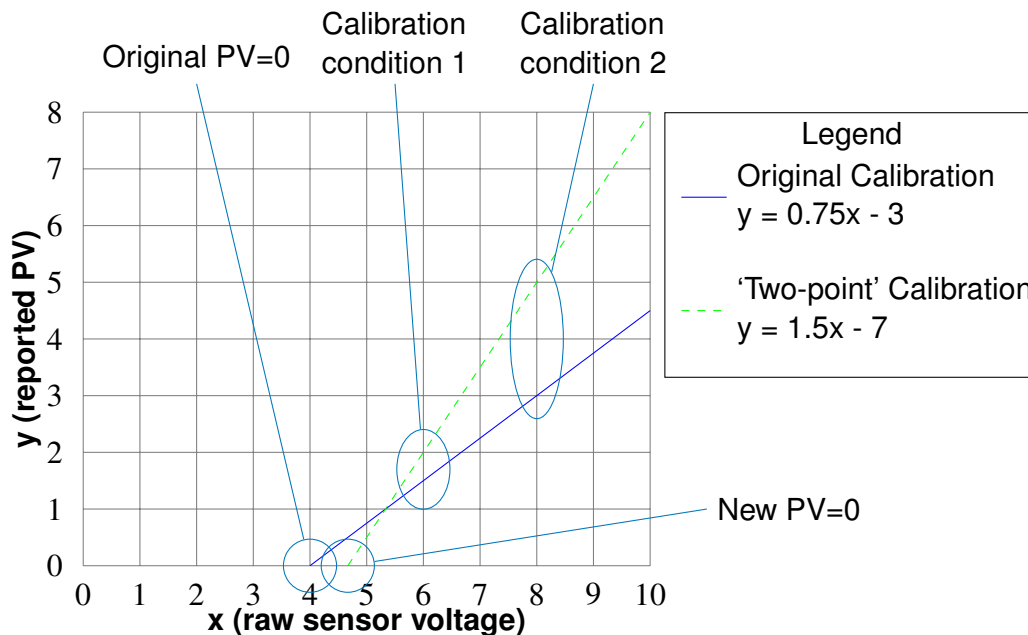

In the above example, the calibration would have been performed when the raw sensor voltage was 6 for the first point and 8 for the second point. With the original calibration values, the PV would have been 1.5 at the first point and 3 at the second point, but the operator knew that the actual PVs should be 2 under the first condition, and 5 under the second condition. This calibration type resulted in the slope, intercept, and PV=0 all changing.

This calibration type is applicable to sensors for which 2 conditions can be quickly and reliably created: A classic example of this would be to take a nonsterile pH sensor and expose it to 2 different calibration buffer solutions. This is not possible on the PBS-3 SUS without breaking the sterility of the vessel, and this calibration type is not applicable to the PBS-3 SUS.

Span and Offset

Both 'span' and 'offset' calibrations take a single new PV from the operator under a specific condition. A 'span' calibration preserves the PV=0 condition from the original calibration by changing the slope and intercept, whereas an 'offset' calibration preserves the slope from the original calibration, and the intercept and PV=0 condition change. The software refers to 'offset' calibrations as 'one-point' calibrations.

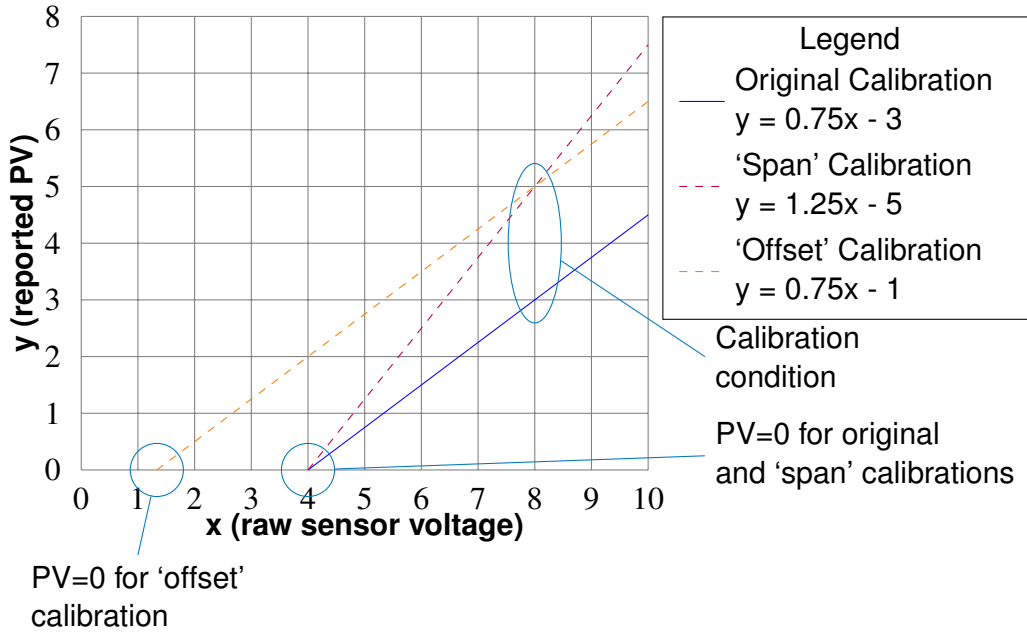

In the above example, the calibration would have been performed when the raw sensor voltage was 8. With the original calibration values, the PV would have been 3, but the operator knew that the actual PV should be 5 under that condition. If the operator had chosen to perform a 'span' calibration, the PV=0 condition would have been preserved, and the slope and intercept would have changed. If the operator instead had chosen to perform an 'offset'/'one-point' calibration, the original slope of 0.75 would have been preserved, and the intercept and PV=0 condition would have changed.

Whether it is more important to preserve the original calibration's slope by performing an 'offset'/'one-point' calibration, or it is more important to preserve the original calibration's PV=0 condition by performing a 'span' calibration, depends on the sensor, and how relevant the PV=0 condition is:

- For the pH sensor, pH=0 is not a relevant condition, and therefore 'offset'/'one-point' calibrations, and not 'span' calibrations, should be performed.
- For the DO sensor, DO=0% is a relevant condition, and therefore 'span' calibrations, and not 'offset'/'one-point' calibrations, should be performed.
- For the Level sensor, Level=0 L is a relevant condition, and should have been set by performing a 'zero' calibration on the empty vessel. Therefore after filling a vessel, a 'span' calibration is appropriate to perform. However, if during a run there is a change made to the tubing configuration or sensor cable positioning which would affect the weight of the vessel but not the actual volume of liquid inside, an 'offset'/'one-point' calibration may be appropriate to perform. This would be somewhat unusual, so please consult PBS Biotech Technical Support with any questions.

Manual

Calibration slope and intercept values can also be manually entered; however, this should not be done without consulting PBS Biotech Technical Support.

Sequences

Sequences are configured and run from the Hello UI. The engine uses a simple interpreter which reads and writes directly to the bioreactor's internal state.

Actions and Looping

“Set” – Select this action when you want to set a variable to a specific value.

For example, selecting the variable “AgModeUser (Agitation)” and then selecting the “Auto” button would result in the sequence changing the agitation mode to “Auto.”

“Wait” – Select this action when you want the sequence to wait for a specified period of time before moving on to the next step. For example, selecting this action and then entering “10” in the ‘Seconds’ field would result in the sequence waiting for 10 seconds before moving on to the next step.

“Wait Until” – Select this action when you want a variable to reach a specific value or state before the sequence moves on to the next step. For example, selecting the variable “AgPV(RPM) (Agitation),” selecting “>=

(greater than or equal to)” in the ‘Compare’ field, and then entering “10” in the number field would result in the sequence waiting until the agitation present value equaled 10 RPM before moving on to the next step.

“**Loop**” – Select this action when you want the entire sequence to loop until the user stops the sequence. To configure a sequence to loop, edit the sequence, click ‘Loop,’ and then save.

Which Variable Types Sequences Can Change

For a complete list of variables the software uses, see Appendix 4 on page 211.

User Source

All variables which are “User” Source can be changed using a sequence. This includes variables such as modes, set points, and pump speeds. Changing these variables with a sequence works the same as changing them through the Hello UI.

System Source

All variables which are “System” Source can be changed using a sequence. Changing calibration slopes and intercepts with a sequence is the same as changing them by performing a calibration, and changing “System” Source variables with a corresponding System Variable are the same as changing a setting in the Settings editor. However, changing other “System” Source variables via sequence should be treated as temporary; if the RIO is rebooted or loses power, the changes will be reverted when it is booted up again.

Sensor and Calculated Sources

Other variables cannot be changed using a sequence. These variables include calculated values such as PVs and raw sensor values.

Other Information About Sequences

Sequences can only be run one at a time, and cannot refer to other sequences.

Ending a sequence prematurely causes the sequence to end at the current step, and does not reset anything. Consider the following sequence:

1. Set “Pumps&ValvesPumpUser1” to Slow
2. Wait 60 seconds
3. Set “Pumps&ValvesPumpUser1” to Off

If the above sequence were stopped after only 30 seconds, the pump would continue to run, until a user stopped the pump themselves in the “Control Pumps” menu. Similarly, after a user starts that sequence, the pump can still

be stopped in the “Control Pumps” menu.

Users should also remain conscious of any user-selectable parameters that may interfere with a sequence step.

Reports

Reports contain data from a specified time span or from an individual batch. They are generated as .csv files with the report type and creation time as their default name. As part of the report generation process, reports can be exported via email, to a connected USB drive, or to a connected network drive. They can be emailed to the user who generated them (if the user has a registered email address), individual email addresses manually entered, or to all users in a user group who have a registered email address. Reports can also be exported any time after they were generated using the “Export” menu from the “Actions” tab.

Types

Process Data – Contain process data logged for variables specified in the Logger Settings.log file. See below for more information.

User Events – Contains all actions a user takes, except screen navigation. When a configuration file is created, its name and contents are included in the user event. For additional edits to a configuration file, its name and the changes are included in the user event. When a configuration file is made active, its name is included in the user event.

Errors – Contains information used for debugging, and is not necessary for users under ordinary circumstances.

Alarms – Contains information about alarms that are generated, when they are acknowledged, and which user acknowledged them.

Sequence Steps – For each sequence ran, contains the start time of the sequence, all sequence steps executed by the software, what time the steps were started, and the time the sequence ended.

Process Data Recording

The Logger Settings.log file determines which variables' process data will be recorded. In addition to selecting what data to record, each variable has a “deadband” that says its value will be recorded if it changes by the deadband amount. The System “Max Data Log Interval (min)” setting determines how frequently the data will be recorded if it is changing less than the deadband.

For example, if the agitation PV is set to be recorded with a deadband of 1 RPM, and the “Max Data Log Interval” is 15 seconds, the following chart shows when the PV will be recorded:

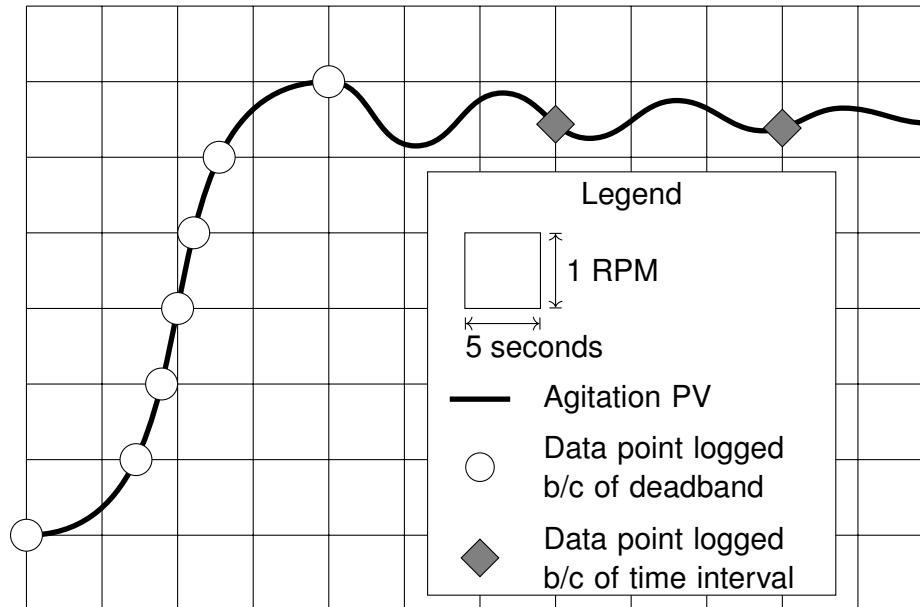

The combination of time-dependent data recording and change-related data recording can be used to ensure that useful data is recorded without flooding the database.

For definitions of all logger variables and default deadbands, see Appendix 4 on page 211.

Database

The active database is called Historical Records.db and contains all data recorded by the system. Its contents are compatible with any application that can read SQLite format.

Take Sample

For instructions to take a sample manually, see “Take Sample” on page 100.

Note: The Sample pump does not have speed control, and some users are more comfortable taking a manual sample using one of the Addition Pumps set to ‘Slow’ instead. They are controlled in the Hello UI’s “Control Pumps” menu, and because they are not bi-directional, the sample tubing must be removed and repositioned while taking a sample.

Do not attempt to combine samples for different types of analyses, for example measuring the pH of a sample that is going to be processed for cell counts. This will introduce more variability and error into the cell count. Each sample should be unique.

When validating any sampling and measurement method, multiple samples should be taken and compared to understand the inherent variation.

Sampling for Cell Counting

Sample should be representative of the culture – A representative sample should have the same proportion of healthy cells as in the vessel. If the cells are growing in aggregates or microcarrier clumps, those amounts and morphologies should be reflected in the sample as well.

Volume – A sample of 10 mL or larger is recommended for cell counts.

Sample Method – Factors which impact how representative a sample is are the shear force the sample is subjected to as it is taken, the speed at which the sample is taken, and the location in the vessel from which the sample is taken. Passing a sample through a pump or small connectors can subject the sample to shear force and affect cell health/viability, and affect the size/shape of aggregates or microcarrier clumps. Sampling speed and location can impact the number of total cells contained in a sample.

Handling Sample – For viability counts, the sample should be handled and processed as quickly and gently as possible to avoid artificially increasing the percent of dead or unhealthy cells.

Counting Cells in Sample – Users should validate their cell count method by taking multiple samples and comparing them, to understand the inherent variation.

Sampling for pH Measurement

Concerns – As a sample is removed and manipulated, CO₂ in the cell culture medium can be stripped out and replaced with air, which will increase the pH. A sample which is left to sit in ambient conditions will also experience off-gassing, which will have the same effect as actively stripping out the CO₂. The reverse can also happen; cellular metabolic activity may continue in the sample, causing the CO₂ and/or lactic acid to be higher than the concentration in the vessel.

Volume – A sample of sufficient size for the offline pH meter to read it should be taken.

Sample Method – Minimize turbulence and air exposure while taking the sample. The bioreactor tubing is gas permeable, so as soon as liquid leaves the vessel environment it is changing from its in situ conditions.

Handling Sample – Minimize turbulence and air exposure while handling the sample - perform the measurement as quickly as possible.

Measuring Sample – Getting a measurement as quickly as possible should be the priority. A dedicated benchtop pH meter will give a measurement more quickly than a metabolite analyzer, for example. The sampling and pH measurement methods can also be validated. Before inoculating with cells, when the % CO₂ composition is manually set and the pH PV has stabilized, the measured pH should match the expected pH from the “NaHCO₃, CO₂%, and pH at 37 °C” chart on page 138, given the % CO₂ composition and sodium bicarbonate concentration of the medium. Taking a sample can introduce air and strip out CO₂, causing the sample’s measured pH to be higher than that in the actual bioreactor. Comparing the sample’s measured pH to the theoretical pH based on the % CO₂ composition and sodium bicarbonate concentration of the medium is a good way to verify that the samples are being taken and handled appropriately.

Sampling for DO Measurement

Sampling for measuring the DO can be done regularly, but DO calibration should only be performed if DO sensor drift has been confirmed to be a significant issue. It’s possible to introduce significant error by measuring the DO of a sample, and this concern should be weighed against concerns about sensor drift.

Concerns – As a sample is removed and manipulated, it will be rapidly equilibrating to the gas composition of atmospheric air, which will result in the DO of the sample rapidly approaching 100%. A sample which is left to sit in ambient conditions will also experience off-gassing, which will have the same effects as actively stripping out the other gases. Cellular metabolic activity might also continue in the sample, causing the O₂ to be lower than that of the media in the vessel.

Volume – A sample of sufficient size for the offline gas analyzer to read it should be taken.

Sample Method – Minimize turbulence and air exposure while taking the sample. The bioreactor tubing is gas permeable, so as soon as liquid leaves the vessel environment it is changing from its in situ conditions.

Handling Sample – Minimize turbulence and air exposure while handling the sample - perform the measurement as quickly as possible.

Measuring Sample – Getting a measurement as quickly as possible should be the priority. A blood gas analyzer will give a measurement more quickly than a metabolite analyzer, for example. The sampling and DO measurement methods can also be validated. Before inoculating with cells, when the % composition of the CO₂ and N₂ in the headspace is manually set and the DO PV has stabilized, the measured DO should match the percent of air entering the headspace. Comparing the sample's measured DO to the theoretical DO is a good way to verify that the samples are being taken and handled appropriately.

Load Vessel

The Load Vessel feature allows the database to store the vessel part number and serial number used for particular batches.

Batch

Rather than manually recording the start and end dates of various runs, users can start a new batch when they start a new run and end it after harvest. This makes it easier to access the relevant data for generating a report.

Advanced View

The “Advanced” menu allows the user to see more detailed information than is displayed in the Dashboard.

Windows/HMI Log Off

Users can log out of the HMI computer from the Hello UI. This feature is used when a customer's IT department requires access to their Admin account on the Windows/HMI computer. Internal protocols must be followed to ensure that nobody with access to the Windows Admin account modifies or deletes any data.

Restart

Users can restart the HMI computer from the Hello UI. Because of the unique architecture combining the RIO controller and HMI, the user is able to reboot the HMI without interrupting run control. If the HMI stops responding or a software update requires a restart, the user can reboot the HMI without losing crucial functionality. For instructions to restart the HMI, see “Restarting the HMI Computer” on page 74.

Alarms

The Alarms configuration file (Alarms.alm) is configured in the Hello UI. Alarm monitoring is handled by the RIO, while user alerts are displayed in the Hello UI, and emails about alarms are sent by the HMI computer.

There are two types of alarms on the PBS-3 SUS:

Process Alarms – Triggered when the PV deviates outside the user-defined High and Low range, or High High and Low Low range, for each variable. These ranges are defined in the Process Alarms group of the “System Variables” editor.

Failure Alarms – Triggered when parameters fall outside pre-defined ranges, which indicates that sensors or other hardware have failed. For definitions of all alarms, see Appendix 2 on page 202.

All alarms can be configured in the Alarms editor. There are three settings for alarms on the PBS-3 SUS: Notify, Audible, and Email. Users can select all three alarm settings for all alarm variables.

Notify – If the selected alarm is triggered, an alert will appear in the “Alarms” tab of the Hello UI.

Audible – If the selected alarm is triggered, the software will alert users to a failure by sounding the built-in buzzer. The sound of the buzzer can be adjusted by changing the “Buzzer Period” setting in the Settings editor.

Email – If the selected alarm is triggered, a notification email will be sent to the list of entered email addresses in the ‘Email List’ (see “Configuring Alarms Email List” on page 59). For more information on how to configure email settings, see “Configuring Email Function” on page 57.

Users may acknowledge an alarm while the condition which triggered it is still being met. The alarm will regenerate once the amount of time specified in the Alarm “Snooze Time” setting has elapsed.

When a user clicks “Acknowledge All” to acknowledge all alarms, alarms of all types will be snoozed until the amount of time specified in the Alarm “Snooze Time” setting has elapsed. This also applies to alarm types which were not previously triggered.

For more information on acknowledging alarms, see “Alarms” on page 122. For information on changing the Alarm “Snooze Time,” see “Settings/System Variables” on page 123. For default alarms configurations, see Appendix 3 on page 207.

Settings

The System Variables configuration file (System Variables.sys) is configured in the System Variables editor (see “Settings/System Variables” on page 123). While some settings are meant to be user-configurable, it is possible to severely impair functionality of the PBS-3 SUS by changing certain settings. For a complete list of all settings, their definitions, and whether PBS Biotech Technical Support recommends changing them, see Appendix 1 on page 178.

User Accounts

Users are required to log in with an individual user name and password to access the Hello UI. Users can choose to log out of the Hello UI, and local users are logged out automatically after ten (10) minutes of inactivity (the automatic logout time is configurable for domain users). Changes a user makes while they are logged in are recorded in the database and can be exported in a User Events report.

Use of shared or generic accounts is not recommended in regulated environments or when traceability of user actions is desired. Users in regulated environments are responsible for ensuring that any such use of accounts is managed appropriately.

Local users have user names, passwords, user groups, and optional email addresses to receive emailed reports. Domain account details are managed on the domain controller by the customer’s IT team. Only username and permission assignments are used by the PBS Software. For information on configuring users and user groups, see “Configuring Local Users and Groups” on page 41.

User Group Permissions

Permission groups can be configured to have a combination of the following permission options:

Operation

These control access to the features required for day-to-day operations of the PBS-3 SUS.

Controls – Allows users to set agitation, temperature, DO, pH, main gas, and filter oven, and to turn pumps on and off, and change their direction and speed (if applicable). When this permission is not granted, the user is unable to click the corresponding buttons in the Dashboard and the “Advanced View,” “Control Pumps,” and “Sample” menus of the Hello UI.

Acknowledge Alarms – Allows the user to acknowledge alarms. When this permission is not granted, the user is unable to click any of the unacknowledged alarms under the “Alarms” tab.

Start Sequence – Allows the user to start a sequence. When this permission is not granted, the user is unable to click the “Start” button in the “Sequence” menu.

End Sequence – Allows the user to end a sequence. When this permission is not granted, the user is unable to click the “Stop” button in the “Sequence” menu.

Main Light – Allows the user to turn the Main Light on and off. When this permission is not granted, the user is unable to click the “Main Light” button in the “Actions” tab.

Process Configuration

These control access to the features required to start and end a batch run on the PBS-3 SUS.

Activate Alarm Settings – Allows users to Activate Alarms files, and to test the buzzer. The “Alarm Settings Editor” permission is required to edit the Alarms files.

Activate System Variables – Allows users to make System Variables files active. The “System Variables Editor” permission is required to edit the System Variables files.

Activate Logger Settings – Allows users to make Logger Settings files active. The “Logger Settings Editor” permission is required to edit the Logger Settings files.

Batch Events – Allows users to start and end batches, and load and unload vessels.

Reports – Allows users to create and export reports.

Process Calibration – Allows users to perform ordinary calibrations on pH, DO, and Level. Only ‘one-point’ calibrations should be performed on single-use pH sensors, and only ‘span’ calibrations should be performed on single-use DO sensors. ‘Two-point’ calibrations should not be performed on pH or DO sensors without consulting PBS Biotech Technical Support.

Advanced Configuration

These control access to the features required to perform advanced configurations on the PBS-3 SUS. These functions are typically used during initial configuration or process development, but not day-to-day operation.

Sequence Editor – Allows users to add, edit, and delete sequences.

Email Settings – Allows users to configure the email settings for the PBS-3 SUS. This includes the SMTP server or Email server settings, the email list for alarm notifications, and the ‘Alarm Email Snooze Time.’

Alarm Settings Editor – Allows users to configure alarms to be set to Notify, Audible, and/or Email, and to test the buzzer. Users with this permission can create new Alarms files, edit existing Alarms files, and delete Alarms files. The “Activate Alarm Settings” permission is required to edit the Alarms file that is currently active.

System Variables Editor – Allows users to edit the values of system variables. Users with this permission can create new System Variables files, edit existing System Variables files, and delete System Variables files. The “Activate System Variables” permission is required to edit the System Variables file that is currently active.

Logger Settings Editor – Allows users to configure what data is recorded and how often. Users with this permission can create new Logger Settings files, edit existing Logger Settings files, and delete Logger Settings files. The “Activate Logger Settings” permission is required to edit the Logger Settings file that is currently active.

Equipment Calibration – Allows users to perform calibrations on Temperature, Filter Oven, and the MFCs. Also allows users to enter calibration slope and intercept values manually. These operations should not be performed without consulting PBS Biotech Technical Support.

Administration

These control access to features required for administrative actions on the PBS-3 SUS.

Account Management – Allows admins to configure Users and User Groups settings, including permissions, passwords, password rules, emails, and assigned User Groups, and configure Domain login settings.

Backup Configuration – Allows users to schedule automatic backups and to perform manual backups.

System Management – Allows users to rename the bioreactor, reboot the RIO, sync the RIO time, and shutdown, reboot, and log off of the Windows/HMI computer.

Map Drive – Allows users to manage mapped network drives.

OPC UA Settings – Allows users to configure the bioreactor to connect to other software systems via OPC UA. When this permission is not granted, changes cannot be made in the OPC UA menu, accessed via the “OPC UA” button in the triple bar ≡ (top right corner) menu.

This chapter contains information a customer's IT department may need to install or maintain the PBS-3 SUS.

Bioreactor Computer Architecture

- The control system of the PBS-3 SUS Vertical-Wheel® Bioreactor System (PBS-3 SUS) is accessed through a touchscreen HMI located on the front of the bioreactor housing. Internally, an industrial process computer (IPC) controls UI, data, and configuration, while equipment control and monitoring is performed by an industrial automation controller (RIO)
- The IPC operates PBS Biotech's Hello UI software. This software is responsible for:
 - User Interface, including control panel, readouts, and configuration
 - Data and event logging
 - Enforcing data integrity and security, including access controls and audit trails
 - Sending emails
 - Sending user commands to the RIO controller
- The RIO controller is in charge of:
 - Sensing and control functions
 - Process monitoring, including interlocks and equipment failures
 - Generating the data and event records logged by the Hello UI
 - Running the Sequence (automation) engine

Operating System

The IPC runs on Windows 10 IoT Enterprise LTSC 2021. Access to the operating system is granted to provide access to specific functions not implemented in the PBS Software:

- Date/Time configuration
- NTP server configuration
- Manual import/export of configuration files
- Database archiving
- Static IP configuration

Access to the OS may also be used for configuration and security auditing.

NOTICE PBS Bioreactors are provided with a fully configured, embedded software package. PBS Biotech can only support system modifications made through the PBS Software or performed by PBS Biotech. Installation of any third-party software to the system may void the warranty and cause unexpected failures and data loss.

BIOS

The IPC's BIOS is configured at the factory to prevent booting from any media other than the hard drive installed on the PBS-3 SUS. The BIOS must not be configured to allow booting from any other media. This is to prevent a malicious user from gaining access to the database files and modifying or deleting records, thus violating GMP standards for data integrity.

Reconfiguring the BIOS may result in loss of functionality and compromise data integrity.

The BIOS is provided with a secure, factory default password. It may be changed for security purposes, but this is unnecessary for general use and must be done with extreme caution.

NOTICE To maintain data integrity, internal access to the bioreactor housing must be restricted to authorized personnel only. The BIOS security configuration does not protect against intentional misuse by a person with physical access to the IPC's motherboard or SSD.

Network Connections

- The IPC and RIO communicate through an internal, link-local network connection configured with static IP settings. These settings must not be modified under any circumstance.
- The Local Area Connection to the RIO controller is configured as follows:

IPv4 Address:	100.100.100.5
IPv4 Subnet Mask:	255.255.255.0
IPv4 Default Gateway:	undefined
IPv4 DNS Server:	undefined

NOTICE Do not disable the above network connection, or modify any of its configurations, as that will disrupt communication with the RIO controller.

- The Bioreactor computer may be joined to a local network via the Ethernet port. That network connection may be configured as necessary. By default, the bioreactor will automatically obtain an IP address and connect to the local network.
- The bioreactor's local network address can be found in the About menu. Click the triple bar ≡ (top right corner) and then "About."

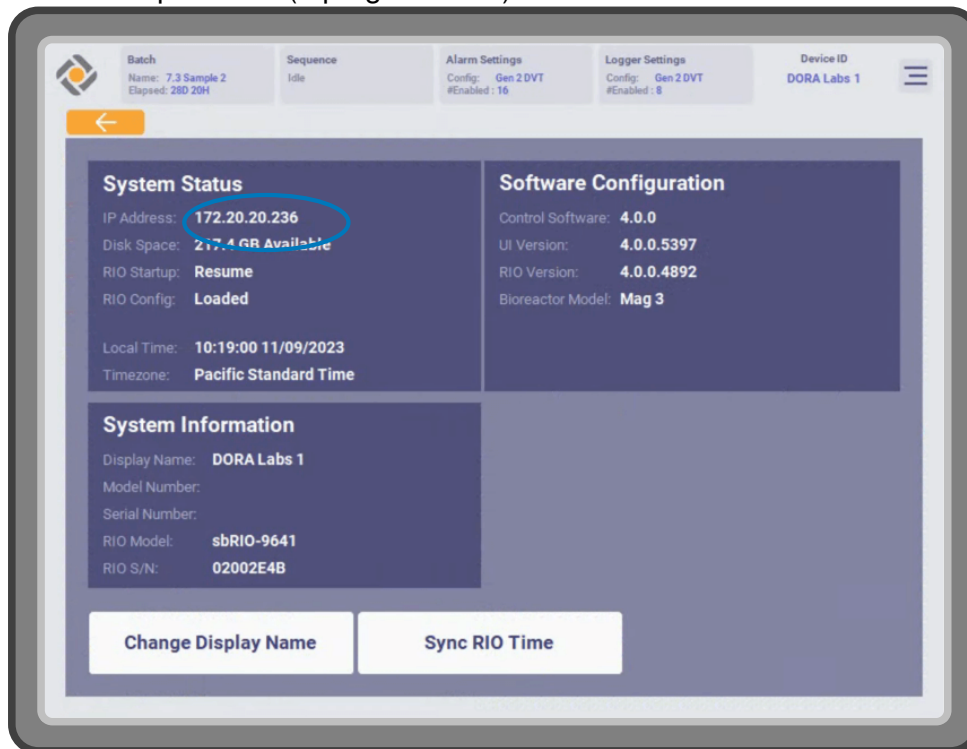

Configuring Domain Login

The bioreactor can be configured so users can log in to the bioreactor with domain credentials. When the Domain login option is enabled, users can still log in using local user accounts; this is useful for maintenance accounts, local administration, and fallback during network issues.

To configure the bioreactor:

1. Log in to the Hello UI using the user name and password of a local account in a group with the “Account Management” permission.
2. Click the triple bar ≡ (top right corner) and then “Administration.”

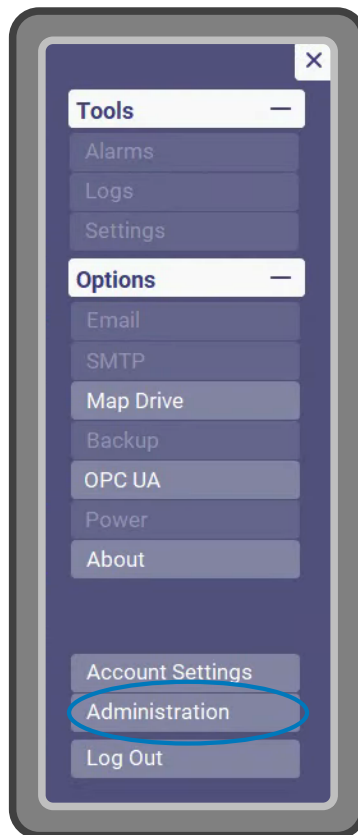

3. Navigate to the “Single Sign On” tab.

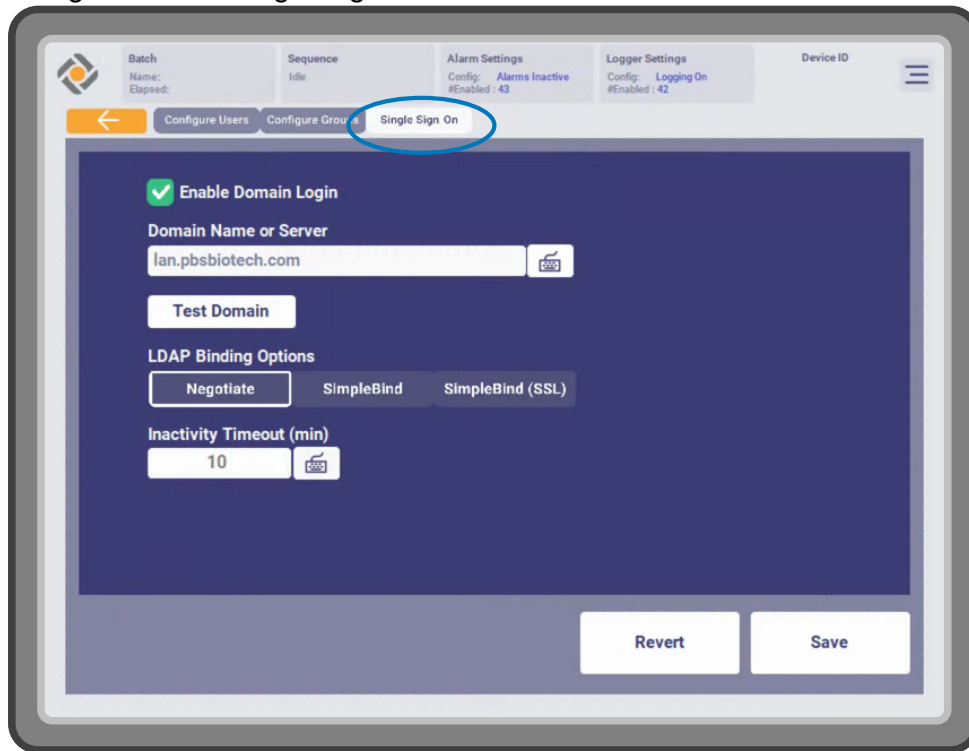

4. Check the “Enable Domain Login”
5. Configure the “Domain Name or Server”
6. Configure the “Inactivity Timeout (min)” if desired
7. Configure the “LDAP Binding Options” if desired

- Click “Test Domain” - if the software is able to interact with the entered Domain Name or Server, a message will appear, “Domain Server is valid.”

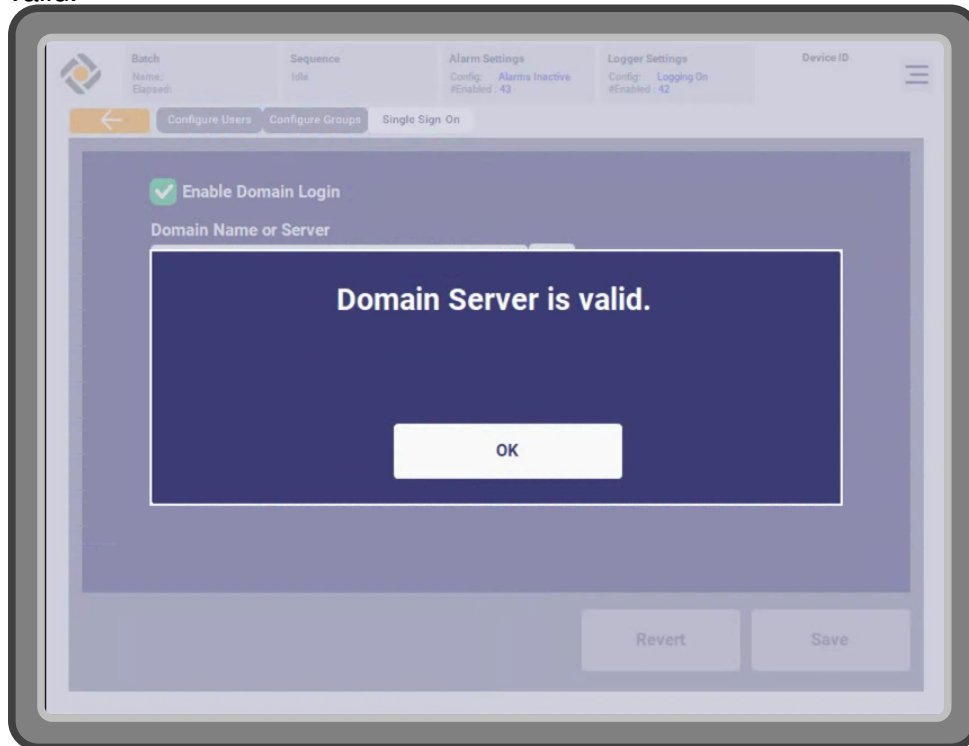

- Click “Save.”

To configure the domain:

Permissions are associated with domain accounts by group assignments queried from the Domain Controller. All permissions supported by the PBS Bioreactor can be granted to domain accounts. Domain accounts with no PBS permissions assigned cannot log in.

For further details, see Document VV-02827 “Bioreactor Single Sign-On Configuration Guide.”

For an explanation of what each Permission does, see “User Group Permissions” on page 161.

Configuring REST API Connectivity

The default PBS Software has an HTTP/REST interface accessed using the following URL format:

<https://<IP Address>/v0/mainvalues>

Configuring the bioreactor's IPC to have a static IP address on the LAN is recommended for this reason (see "Network Connections" on page 166).

Full instructions and documentation can be found in Document VV-04265 "REST API Programming Guide."

Configuring OPC UA Connectivity

The bioreactor can be configured so it can be monitored and controlled via OPC UA by client software systems such as Data Historians, Distributed Control Systems (DCS), Supervisory Control and Data Acquisition (SCADA) systems, and/or Process Information Management Systems (PIMS). This requires applying an optional OPC UA upgrade with a license. Contact sales@pbsbiotech.com for a quote.

Instructions to configure the bioreactor via the Hello UI are below. See Document VV-04264 "OPC-UA Programming Guide" for a full description of the OPC interface.

To configure the bioreactor:

1. Log in to the Hello UI using the user name and password of an account with the "OPC UA Settings" permission.

2. Click the triple bar ≡ (top right corner) and then “OPC UA.”

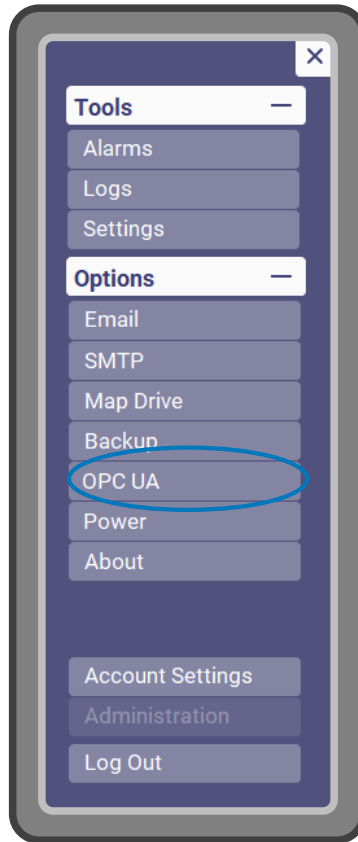

3. Configure the OPC UA settings as desired.

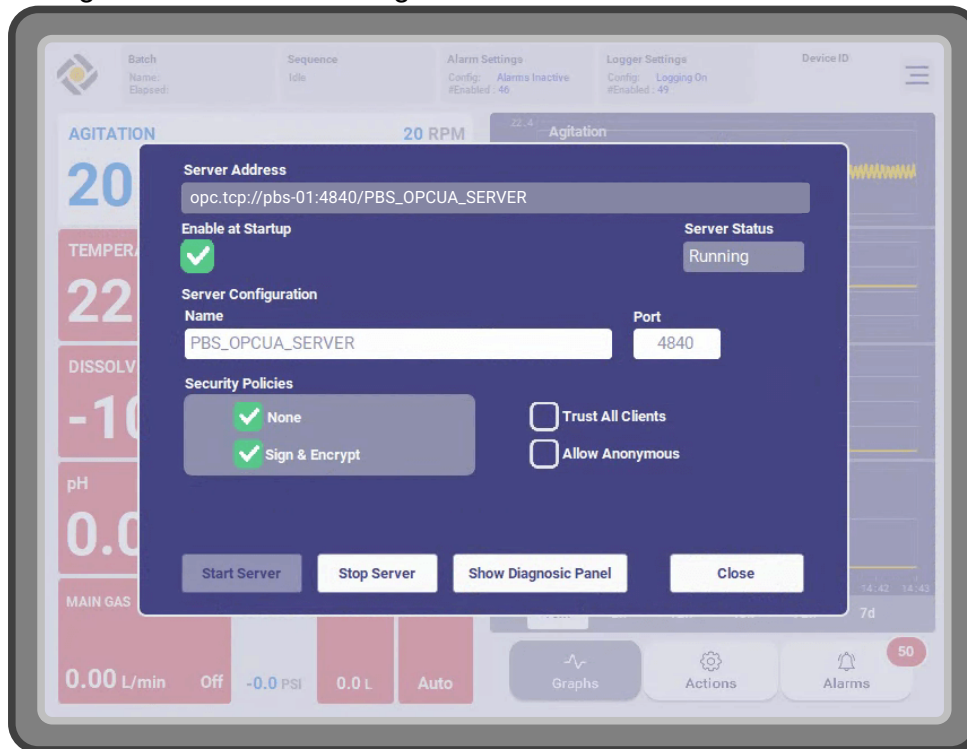
**Indicators:**

Server Address – This is the address of the OPC-UA server on the bioreactor, which clients will connect to. It is empty when the server is not started. The format is:

opc.tcp://<Host Address>:<Port>/<Server Name>

Server Status – Indicates whether the server is currently Running or Idle. If the optional OPC-UA upgrade has not been applied, it will indicate that a license is needed.

Software Configuration:

Enable at Startup – Check this box to configure the PBS Software to run the OPC-UA server when it starts up.

Server Configuration:

Name – While this is user-configurable, it is not recommended to edit this value.

Port – This is the port used by the server. 4840 is the default value.

Security Policies:

None – When checked, a client does not have to provide a certificate to connect to the server, and the communication is not encrypted.

Sign & Encrypt – When checked, a client has to provide a signed certificate to connect to the server, and the communication is

encrypted.

Client Options:

Trust All Clients – When this box is checked, the server will trust certificates from clients even if they are not included in the local trust list (which is separately configured and maintained by IT).

Allow Anonymous – Checking this box allows clients to connect to the server without providing credentials. Any client which does this will only have read access granted to them; they will not be able to make any changes on the bioreactor.

Buttons:

Start Server – Starts the server if it is not running.

Stop Server – Stops the server if it is running.

Show Diagnostic Panel – Shows the actual server with the internal nodes populated, address of the server running, etc.

Close – Closes the OPC UA Settings menu.

4. Click “Close.”

Email

- The PBS software can send emails for the following reasons:
 - To notify users about alarms
 - * The email settings file must be configured for the alarm to be ‘Email’
 - * Either the Alarm Emailing Snooze Time is 0, or more time has passed since the last alarm of that type was emailed
 - * An email is sent to every address in the “Email List” in the triple bar ≡ menu (top right corner) → Email menu
 - To notify users about failed login attempts
 - * The user account will receive an email if it has an associated email address
 - * All user accounts with the “Account Management” permission and which have an associated email address will receive an email
 - To send report files to users
 - * When generating or exporting reports, it is simple to email a copy of the report to the user if the user account has an associated email address

- The network must allow access to an SMTP relay configured in the bioreactor's SMTP Settings menu.

The screenshot shows the 'SMTP Settings' configuration interface. It includes the following fields and controls:

- Sender Address:** pbs@pbscustomer.com
- Password:** *****
- Server:** smtp.office365.com
- Port:** 587
- Enable SSL:** Checked (indicated by a green checkmark)
- Buttons:** Send Test Email, Revert, Save

- Authentication: The system authenticates with the server using the provided sender address and password. If the password is blank, then authentication is not performed.
- Supported SSL Protocols: The system supports TLS 1.2 and TLS 1.3.
- Encryption (SSL=True): SSL protocol will be negotiated with the server and rejected if negotiation fails. If the provided port is 465, the connection will be initiated using ImplicitTls. Otherwise, it will be initiated using STARTTLS.
- When SSL is False, the connection always will be made in plaintext and will not attempt to negotiate encryption.
- Troubleshooting:
 - The PBS Error log may contain additional information regarding errors encountered when configuring SMTP settings.
 - Additional network-level configurations may be necessary to ensure email can be sent.
- Bioreactors are shipped with a default SMTP server configuration using an @pbscustomer.com email specific to the customer.
 - There is an attachment size limit of 35 MB for the default sending

email address. Process data reports may be too large to be emailed, depending on the date range.

- SMS and MMS Gateways:
 - Users can receive alarm notifications as text messages, if the configured SMTP server supports SMS or MMS Gateway.
 - NOTICE** The default SMTP relay provided by PBS Biotech is not guaranteed to support SMS or MMS.
 - This requires entering the user’s mobile phone number as an email address using the SMS gateway domain or MMS gateway domain of their mobile carrier. For example, 8055557272@txt.att.net would be used to send a message to an AT&T mobile with number +1 805-555-7272.
 - The Wikipedia “SMS gateway” page has more information, including a list of gateway domains for US and Canadian carriers: https://en.wikipedia.org/wiki/SMS_gateway#Email_clients

Backups

- The PBS software has a backup feature, which supports two types of backup:
 - Full Backup: This backs up the Historical Records database, the User Configurations database, and all the configuration files and reports.
 - DB Export: This only backs up the Historical Records database.
- Backups can be scheduled to be performed automatically, or they can be performed manually.
- Backups can be saved to any USB drive or network location accessible as a mounted volume (drive letter).
 - NOTICE** PBS Software is only verified to support USB flash drives and network drive locations mapped through the Map Drive feature.
- The “Backup Configuration” permission is required to configure automatic scheduled backups, or to perform manual backups.
- Backing up to a network location:
 - If users desire to back up to a network location, the interface in the Hello UI should be used, by a user account with the “Map Drive” permission. Log in and click the triple bar ≡ menu (top right corner) → Backup menu
 - Users should not configure “net use” directly.

- The network configuration may need to be changed to successfully map a network drive - see “Network Connections” on page 166.

Manually Archiving DBs

The Historical Records database can be manually archived as follows:

1. Make sure the PBS Software is not running. For bioreactors with the GMP configuration, this will require logging in to the ‘Admin’ Windows account.
2. Remove or rename the database file:
C:\ProgramData\PBS Biotech\Database\Historical Records.db
Do not change anything else in the folder.

NOTICE It is recommended that you back up this file so the data can be accessed in future.

3. Reboot the IPC. When the PBS Software opens, it will see it is missing the database, and it will create a new empty one. An alert will be displayed:

Error occurred opening Historical Records database.
Administrator action needed.

To acknowledge the error, click “hide” to close the notification, log in to the Hello UI as any user, and click “dismiss.”

Automatic Updates

- LogMeIn
 - LogMeIn is installed on bioreactors with the R&D configuration. It updates itself automatically, provided it has access to the internet.
 - Preventing these automatic updates is not recommended.
- Windows

Microsoft Service Pack releases and other Windows operating system updates introduce new software that could affect the operation of the system. Updates can cause unexpected behaviors, including automatically restarting the IPC.

PBS bioreactors prevent updates through the following configurations:

- Automatic updates are disabled
- Manual updates through Windows settings are disabled
- The Windows Update Service is disabled

For more information about Windows Updates or cybersecurity considerations, please contact PBS Biotech Technical Support for assistance.

While all system variable settings can technically be changed by the user, many should remain in their default values unless advised by PBS Biotech Technical Support, or unless the user is confident they know what they are doing. Consult the “User May Change” column to determine which of the following categories each system variable falls into:

- X = Should always remain in default value. Do not change unless specifically instructed by PBS Biotech Technical Support.
- ✓ = User may change from default value.
- ! = Use caution. User must be familiar with bioreactor operations. If in doubt, consult PBS Biotech Technical Support.
- N/A = Not applicable for this bioreactor model.

TEMPERATURE

Setting Name	Default Value	Definition	User May Change	Corresponding Global Variable
P Gain (%/C)	50.000	Proportional Gain for the temperature controller.	!	TempHeatDutyControl.PGain (min)
I Time (min)	26.000	Integral Time for the temperature controller.	!	TempHeatDutyControl.ITime (min)
D Time (min)	0.000	Derivative Time for the temperature controller.	!	TempHeatDutyControl.DTime (min)
Alpha	-1.000	Specifies the derivative filter time constant. Increasing this value increases damping of derivative action. It can be a value between 0 and 1, or less than 0, which specifies that no derivative filter is applied.	X	TempHeatDutyControlAlpha
Beta	0.000	Specifies the relative emphasis of set point tracking to disturbance rejection.	X	TempHeatDutyControlBeta

TEMPERATURE (continued)

Setting Name	Default Value	Definition	User May Change	Corresponding Global Variable
Gamma	0.000	Specifies an amount by which to weight the error applied to derivative action. A value of 0 avoids derivative kick, which is the sudden change in controller output that can occur after a change in the set point value.	X	TempHeatDutyControlGamma
Linearity	1.000	Specifies the linearity of the error response. The valid range is 0 to 1.	X	TempHeatDutyControlLinearity
Heat Manual Max (%)	10.000	The maximum main heater duty allowed in Manual mode.	!	TempHeatManMax(%)
Heat Auto Max (%)	50.000	The maximum main heater duty allowed in Auto mode.	!	TempHeatDutyAutoMax(%)
Valid High (C)	110.000	If a temperature sensor registers a measurement above this value, the software assumes the temperature sensor is experiencing an error condition, and triggers a Temperature Sensor Failure (range) Alarm.	!	TempValidMax(C)
Valid Low (C)	-5.000	If a temperature sensor registers a measurement below this value, the software assumes the temperature sensor is experiencing an error condition, and triggers a Temperature Sensor Failure (range) Alarm.	!	TempValidMin(C)

FILTER OVEN

Setting Name	Default Value	Definition	User May Change	Corresponding Global Variable
P Gain (%/C)	100.000	Proportional Gain for the filter oven controller.	X	FilterOvenDutyControl.Gain (%/C)
I Time (min)	0.030	Integral Time for the filter oven controller.	X	FilterOvenDutyControl.ITime (min)
D Time (min)	0.000	Derivative Time for the filter oven controller.	X	FilterOvenDutyControl.DTime (min)
Alpha	-1.000	Specifies the derivative filter time constant. Increasing this value increases damping of derivative action. It can be a value between 0 and 1, or less than 0, which specifies that no derivative filter is applied.	X	FilterOvenDutyControlAlpha
Beta	1.000	Specifies the relative emphasis of set point tracking to disturbance rejection.	X	FilterOvenDutyControlBeta
Gamma	0.000	Specifies an amount by which to weight the error applied to derivative action. A value of 0 avoids derivative kick, which is the sudden change in controller output that can occur after a change in the set point value.	X	FilterOvenDutyControlGamma
Linearity	1.000	Specifies the linearity of the error response. The valid range is 0 to 1.	X	FilterOvenDutyControlLinearity

FILTER OVEN (continued)

Setting Name	Default Value	Definition	User May Change	Corresponding Global Variable
Heat Manual Max (%)	100.000	The maximum filter oven heater duty allowed in Manual mode.	X	FilterOvenDutyRangeManMax (%)
Heat Auto Max (%)	100.000	The maximum filter oven heater duty allowed in Auto mode.	X	FilterOvenDutyRangeAutoMax (%)

AGITATION

Setting Name	Default Value	Definition	User May Change	Corresponding Global Variable
P Gain (%/RPM)	0.100	Proportional Gain for the agitation controller.	!	AgPowerControl.PGain (%/RPM)
I Time (min)	0.010	Integral Time for the agitation controller.	!	AgPowerControl.ITime (min)
D Time (min)	0.000	Derivative Time for the agitation controller.	!	AgPowerControl.DTime (min)
Alpha	-1.000	Specifies the derivative filter time constant. Increasing this value increases damping of derivative action. It can be a value between 0 and 1, or less than 0, which specifies that no derivative filter is applied.	X	AgControlAlpha
Beta	0.000	Specifies the relative emphasis of set point tracking to disturbance rejection.	X	AgControlBeta

AGITATION (continued)

Setting Name	Default Value	Definition	User May Change	Corresponding Global Variable
Gamma	0.000	Specifies an amount by which to weight the error applied to derivative action. A value of 0 avoids derivative kick, which is the sudden change in controller output that can occur after a change in the set point value.	X	AgControlGamma
Linearity	1.000	Specifies the linearity of the error response. The valid range is 0 to 1.	X	AgControlLinearity
Minimum (RPM)	3.000	If the agitation rate is below this value the software will consider the agitation PV = 0.	!	AgMin(RPM)
Pulse Mode Timeout (s)	N/A	(N/A for PBS-3 SUS) If the software fails to detect agitation in Auto mode for this length of time, it goes into Pulse mode. Should be set equal to the Agitation "Lookup Mode Timeout (s)" setting, to disable Pulse Mode.	N/A	AgPulseModeTimeout(ms)
Lookup Mode Timeout (s)	60.000	If the software fails to detect agitation in Auto mode for this length of time, it goes into Lookup mode.	✓	AgLookupModeTimeout (ms)
Lookup Factor (%/RPM)	1.820	In Lookup mode, the agitation set point is multiplied by this factor to determine the power output to be used.	✓	AgPwrLookupFactor(%/RPM)

AGITATION (continued)

Setting Name	Default Value	Definition	User May Change	Corresponding Global Variable
Power Auto Max (%)	100.000	The maximum power output allowed in Auto mode while the PV is above 0.	✓	AgPowerRange Auto(%).Max
Power Auto Min (%)	10.000	The minimum power output allowed in Auto mode.	!	AgPowerRange Auto(%).Min
Auto Max Startup (%)	20.000	The maximum power output allowed in Auto mode until the PV is above 0.	!	AgAutoMax Startup(%)
Power Manual Max (%)	100.000	The maximum power output allowed in Manual mode.	✓	AgPowerRange ManMax(%)
Number of Magnets	2.000	The number of magnets on the Vertical-Wheel® impeller.	!	AgWheelMagnet Count
Samples To Average	3.000	The number of time periods averaged when calculating the agitation.	X	AgWheelSamples ToAverage

pH

Setting Name	Default Value	Definition	User May Change	Corresponding Global Variable
Rate Fail Delta PV	1.000	If the pH changes by more than this value in the pH “Rate Fail Delta Time (s)” time, the software assumes the pH sensor is experiencing an error condition, and triggers a “pH Sensor Failure (rate)” alarm.	✓	pHRateFailDelta PV

pH (continued)

Setting Name	Default Value	Definition	User May Change	Corresponding Global Variable
Rate Fail Delta Time (s)	60.000	If the pH changes by more than the pH “Rate Fail Delta PV” value in this time, the software assumes the pH sensor is experiencing an error condition, and triggers a “pH Sensor Failure (rate)” alarm.	✓	pHRateFailDelta Time(ms)
CO2 P Gain (%/pH)	-200.000	Proportional Gain for the pH CO ₂ controller.	!	pHCO2 Control.PGain(%)
CO2 I Time (min)	10.000	Integral Time for the pH CO ₂ controller.	!	pHCO2 Control.ITime (min)
CO2 D Time (min)	0.000	Derivative Time for the pH CO ₂ controller.	!	pHCO2 Control.DTime (min)
CO2 Alpha	-1.000	Specifies the derivative filter time constant. Increasing this value increases damping of derivative action. It can be a value between 0 and 1, or less than 0, which specifies that no derivative filter is applied.	X	pHCO2Control Alpha
CO2 Beta	1.000	Specifies the relative emphasis of set point tracking to disturbance rejection.	X	pHCO2Control Beta

pH (continued)

Setting Name	Default Value	Definition	User May Change	Corresponding Global Variable
CO2 Gamma	0.000	Specifies an amount by which to weight the error applied to derivative action. A value of 0 avoids derivative kick, which is the sudden change in controller output that can occur after a change in the set point value.	X	pHCO2Control Gamma
CO2 Linearity	1.000	Specifies the linearity of the error response. The valid range is 0 to 1.	X	pHCO2Control Linearity
CO2 Manual Max (%)	100.000	The maximum CO ₂ composition in the main gas flow allowed in Manual mode.	✓	pHCO2ManMax (%)
CO2 Auto Max (%)	30.000	The maximum CO ₂ composition in the main gas flow allowed in Auto mode.	✓	pHCO2AutoMax (%)
Base P Gain (%/pH)	10.000	Proportional Gain for the pH base controller.	!	pHBaseDuty Control.PGain(%)
Base I Time (min)	50.000	Integral Time for the pH base controller.	!	pHBaseDuty Control.ITime (min)
Base D Time (min)	0.000	Derivative Time for the pH base controller.	!	pHBaseDuty Control.DTime (min)

pH (continued)

Setting Name	Default Value	Definition	User May Change	Corresponding Global Variable
Base Alpha	-1.000	Specifies the derivative filter time constant. Increasing this value increases damping of derivative action. It can be a value between 0 and 1, or less than 0, which specifies that no derivative filter is applied.	X	pHBaseDutyControlAlpha
Base Beta	1.000	Specifies the relative emphasis of set point tracking to disturbance rejection.	X	pHBaseDutyControlBeta
Base Gamma	0.000	Specifies an amount by which to weight the error applied to derivative action. A value of 0 avoids derivative kick, which is the sudden change in controller output that can occur after a change in the set point value.	X	pHBaseDutyControlGamma
Base Linearity	1.000	Specifies the linearity of the error response. The valid range is 0 to 1.	X	pHBaseDutyControlLinearity
Base Manual Max (%)	0.000	The maximum base pump duty allowed in Manual mode.	✓	pHBaseDutyManMax(%)
Base Auto Max (%)	50.000	The maximum base pump duty allowed in Auto mode.	✓	pHBaseAutoMax

pH (continued)

Setting Name	Default Value	Definition	User May Change	Corresponding Global Variable
A Use Temp Comp?	0.000	Use (1) or do not use (0) a temperature compensation factor for pH sensor A. Must be used for reusable pH sensors, and must not be used for single-use pH sensors.	X	pHAUseTemp Comp
Deadband	0.020	The internal deadband of the pH controller. CO ₂ only flows when the pH PV is greater than the pH set point + deadband. Base only flows when the pH PV is less than the pH set point - deadband.	✓	pHDeadband
Valid High (pH)	14.000	If a pH sensor registers a measurement above this value, the software assumes the pH sensor is experiencing an error condition, and triggers a pH Sensor Failure (range) Alarm.	!	pHValidMax
Valid Low (pH)	0.000	If a pH sensor registers a measurement below this value, the software assumes the pH sensor is experiencing an error condition, and triggers a pH Sensor Failure (range) Alarm.	!	pHValidMin

pH (continued)

Setting Name	Default Value	Definition	User May Change	Corresponding Global Variable
Samples To Average	10.000	The number of samples used to calculate a moving average of the pH signal. pH is sampled once per second, meaning a value of 10 Samples To Average corresponds to 10 seconds of data. Note: The corresponding global variable for this value is coerced between 1 and 3600 samples (inclusive). Note: Sampling data is reset when this setting is changed. Allow one second per sample (e.g. 10 seconds for 10 Samples To Average) for the setting to fully take effect. Note: This setting does not apply to data displayed in the Hello UI's calibration menu.	!	pHSensor SamplesTo Average

DO

Setting Name	Default Value	Definition	User May Change	Corresponding Global Variable
Valid High (DO%)	200.000	If a DO sensor registers a measurement above this value, the software assumes the DO sensor is experiencing an error condition, and triggers a DO Sensor Failure (range) Alarm.	!	DOValidMax(%)
Valid Low (DO%)	-10.000	If a DO sensor registers a measurement below this value, the software assumes the DO sensor is experiencing an error condition, and triggers a DO Sensor Failure (range) Alarm.	!	DOValidMin(%)
O2 P Gain (%/DO%)	1.500	Proportional Gain for the DO O ₂ controller. The same value should be used whether O ₂ is flowing through the overlay or being sparged.	!	DOO2Control Mag.PGain(%/%)
O2 I Time (min)	120.000	Integral Time for the DO O ₂ controller. The same value should be used whether O ₂ is flowing through the overlay or being sparged.	!	DOO2Control Mag.ITime(min)
O2 D Time (min)	0.000	Derivative Time for the DO O ₂ controller. The same value should be used whether O ₂ is flowing through the overlay or being sparged.	!	DOO2Control Mag.DTime(min)

DO (continued)

Setting Name	Default Value	Definition	User May Change	Corresponding Global Variable
O2 Alpha	-1.000	Specifies the derivative filter time constant. Increasing this value increases damping of derivative action. It can be a value between 0 and 1, or less than 0, which specifies that no derivative filter is applied.	X	DOO2Control Alpha
O2 Beta	0.000	Specifies the relative emphasis of set point tracking to disturbance rejection.	X	DOO2Control Beta
O2 Gamma	0.000	Specifies an amount by which to weight the error applied to derivative action. A value of 0 avoids derivative kick, which is the sudden change in controller output that can occur after a change in the set point value.	X	DOO2Control Gamma
O2 Linearity	1.000	Specifies the linearity of the error response. The valid range is 0 to 1.	X	DOO2Control Linearity
O2 Manual Max (%)	100.000	The maximum O ₂ composition in the main gas flow allowed in Manual mode.	✓	DOO2RangeMan Max(%)
O2 Auto Max (%)	100.000	The maximum O ₂ composition in the main gas flow allowed in Auto mode.	✓	DOO2RangeAuto Max(%)
N2 P Gain (%/DO%)	-5.000	Proportional Gain for the DO N ₂ controller.	!	DON2 Control.PGain (%/%)

DO (continued)

Setting Name	Default Value	Definition	User May Change	Corresponding Global Variable
N2 I Time (min)	50.000	Integral Time for the DO N ₂ controller.	!	DON2Control.ITime (min)
N2 D Time (min)	0.000	Derivative Time for the DO N ₂ controller.	!	DON2Control.DTime (min)
N2 Alpha	-1.000	Specifies the derivative filter time constant. Increasing this value increases damping of derivative action. It can be a value between 0 and 1, or less than 0, which specifies that no derivative filter is applied.	X	DON2Control Alpha
N2 Beta	0.000	Specifies the relative emphasis of set point tracking to disturbance rejection.	X	DON2Control Beta
N2 Gamma	0.000	Specifies an amount by which to weight the error applied to derivative action. A value of 0 avoids derivative kick, which is the sudden change in controller output that can occur after a change in the set point value.	X	DON2Control Gamma
N2 Linearity	1.000	Specifies the linearity of the error response. The valid range is 0 to 1.	X	DON2Control Linearity
N2 Manual Max (%)	100.000	The maximum N ₂ composition in the main gas flow allowed in Manual mode.	✓	DON2RangeMan Max(%)

DO (continued)

Setting Name	Default Value	Definition	User May Change	Corresponding Global Variable
N2 Auto Max (%)	100.000	The maximum N ₂ composition in the main gas flow allowed in Auto mode.	✓	DON2RangeAuto Max(%)
Deadband (DO%)	1.000	The internal deadband of the DO controller. N ₂ set point is DO set point + deadband, and O ₂ set point is DO set point - deadband.	✓	DODeadband(%)

LEVEL

Setting Name	Default Value	Definition	User May Change	Corresponding Global Variable
Empty Level (V)	0.000	If the level sensor is below this voltage, the system recognizes the level PV = 0.	!	LevelCal Cluster.Level Empty(V)
Empty Level (L)	0.000	If the level PV is below this value, the software recognizes the level PV = 0.	!	LevelCal Cluster.Level Empty(L)
Enable Sensor (0 or 1)	1.000	If the level sensor is enabled (1), the "Level" box is displayed in the dashboard and all level-related interlocks are in place. Disabled (0), there is no "Level" box in the dashboard, and no level-related interlocks.	✓	LevelSensor Enable
CalLevelSlope Max(psi/V)	9000	The maximum level slope value allowed during calibration.	!	CalLimits Level.CallLevel SlopeMax(psi/V)
CalLevelSlope Min(psi/V)	5000	The minimum level slope value allowed during calibration.	!	CalLimits Level.CallLevel SlopeMin(psi/V)

LEVEL (continued)

Setting Name	Default Value	Definition	User May Change	Corresponding Global Variable
CalLevel InterceptMax (psi)	0.000	The maximum level intercept value allowed during calibration.	!	CalLimits Level.CallLevel InterceptMax(psi)
CalLevel InterceptMin (psi)	-10.000	The minimum level intercept value allowed during calibration.	!	CalLimits Level.CallLevel InterceptMin(psi)

PRESSURE

Setting Name	Default Value	Definition	User May Change	Corresponding Global Variable
Disconnected Pressure (V)	0.005	If the absolute value of the voltage associated with pressure PV is greater than the disconnected pressure voltage, the software recognizes the pressure sensor is disconnected.	X	Pressure Disconnected(V)
Reusable Sensor (0 or 1)	0.000	Tells the software what kind of pressure sensor is used on the bioreactor.	X	Reusable Sensor (0 or 1)

GAS DATA

Setting Name	Default Value	Definition	User May Change	Corresponding Global Variable
CO2 Min (LPM)	0.030	This corresponds to the shutoff flowrate of the CO ₂ MFC - the MFC cannot flow reliably below this rate. Any requested flows below this will be delivered by the software as time metered pulses at this flow rate.	X	MFC _{CO2} Min (LPM)
CO2 Off (V)	0.000	This is the voltage sent to the CO ₂ MFC when no gas flow is being requested.	X	MFC _{CO2} Off(V)
N2 Min (LPM)	0.030	This corresponds to the shutoff flowrate of the N ₂ MFC - the MFC cannot flow reliably below this rate. Any requested flows below this will be delivered by the software as time metered pulses at this flow rate.	X	MFC _{N2} Min(LPM)
N2 Off (V)	0.000	This is the voltage sent to the N ₂ MFC when no gas flow is being requested.	X	MFC _{N2} Off(V)
Air Min (LPM)	0.030	This corresponds to the shutoff flowrate of the Air MFC - the MFC cannot flow reliably below this rate. Any requested flows below this will be delivered by the software as time metered pulses at this flow rate.	X	MFC _{Air} Min(LPM)

GAS DATA (continued)

Setting Name	Default Value	Definition	User May Change	Corresponding Global Variable
Air Off (V)	0.000	This is the voltage sent to the Air MFC when no gas flow is being requested.	X	MFCAirOff(V)
O2 Min (LPM)	0.030	This corresponds to the shutoff flowrate of the O ₂ MFC - the MFC cannot flow reliably below this rate. Any requested flows below this will be delivered by the software as time metered pulses at this flow rate.	X	MFCO2Min(LPM)
O2 Off (V)	0.000	This is the voltage sent to the O ₂ MFC when no gas flow is being requested.	X	MFCO2Off(V)
PWM On Time (s)	10.000	Pulse Width Modulation On Time of the MFCs.	!	MFCOnTime(s)
PWM Max Period (s)	200.000	Maximum Pulse Width Modulation Period of the MFCs (period may be smaller, depending on pulsing called for and Gas Data "PWM On Time (s)" setting.	!	MFCMaxPeriod (s)
Mismatch Thresh (V)	0.100	If the voltage the software requests the MFC to deliver is different from the actual voltage the MFC delivers by this value or more, it triggers a Source Pressure Error Alarm.	✓	MFCMismatch Thresh(V)

GAS DATA (continued)

Setting Name	Default Value	Definition	User May Change	Corresponding Global Variable
O ₂ Min Volume (L)	0.010	O ₂ cannot flow above the MFC's minimum until at least this much net volume of O ₂ has flowed since turning DO on. This is known as the "O ₂ Slow Start" feature.	!	O ₂ Min Volume (L)
Manual Max (LPM)	0.500	The maximum main gas flow allowed in Manual mode.	✓	MainGasRange ManMax(LPM)

SAFETY

Setting Name	Default Value	Definition	User May Change	Corresponding Global Variable
Min Ag Power (%)	17.000	If the agitation PV = 0 but the power output to the agitation motor is greater than this value, the software will assume the agitation sensor is experiencing an error condition, and will not interlock the main heater.	X	AgMinPower(%)
Max Temp (C)	45.000	The main heater will be interlocked if temperature PV exceeds this temperature.	✓	InterlockTemp Max(C)
Min Level (L)	0.500	The minimum level below which the temperature controller will be interlocked to avoid heating an empty vessel or heating in the absence of a vessel.	X	LevelMin(L)

SAFETY (continued)

Setting Name	Default Value	Definition	User May Change	Corresponding Global Variable
Max Level (L)	4.000	The maximum level, above which the temperature controller will be interlocked to avoid heating an overfilled vessel. Additionally, pumps will be interlocked to avoid overfilling.	X	LevelMax(L)
Buzzer Period (ms)	100.000	This value affects the quality of sound of the alarm buzzer.	✓	AlarmBuzzer Period(Cycle)
DoorPressure Sensor (0 or 1)	0.000	Tells the software the bioreactor has a door pressure sensor.	X	DoorPressure Sensor

PUMPS

Setting Name	Default Value	Definition	User May Change	Corresponding Global Variable
Aux Low Duty		At "Slow" speed, the addition pump will give this many "on" pulses out of 2^{16} , or 65,536 pulses in total.	✓	Pumps&Valves PumpLowAux Speed
sbRIO* 9641 or 9642:	20000			
sbRIO* 9603:	30000			
Aux Med Duty		At "Medium" speed, the addition pump will give this many "on" pulses out of 2^{16} , or 65,536 pulses in total.	✓	Pumps&Valves PumpMedAux Speed
sbRIO* 9641 or 9642:	30000			
sbRIO* 9603:	52000			
Base On Time (s)	0.100	The base pump turns on in increments of this number.	!	Pumps&Valves BaseOnTime(s)
Base Max Period (s)	240.000	Maximum base pump period (period may be smaller, depending on base pump duty called for and Pumps "Base On Time (s)" setting.	!	Pumps&Valves BaseMaxPeriod (s)
Sample Reverse CW and CCW (0 or 1)	0.000	This value affects the rotation direction of the sample motor.	X	Pumps&Valves ReverseCCand CW

* The sbRIO model is displayed in the Hello UI About menu.

PROCESS ALARMS

These values are meant to be user configurable and used as process deviation alarms. If the PVs exceed the values, alarm events will be triggered.

Setting Name	Default Value	Definition	User May Change	Corresponding Global Variable
Agitation Low Low (RPM)	10.000	If the PV is below this value, the alarm state is "error."	✓	Limits.Agitation Low Low (RPM)
Agitation Low (RPM)	15.000	If the PV is below this value, the alarm state is "warning."	✓	Limits.Agitation Low (RPM)
Agitation High (RPM)	35.000	If the PV is above this value, the alarm state is "warning."	✓	Limits.Agitation High (RPM)

PROCESS ALARMS (continued)

Setting Name	Default Value	Definition	User May Change	Corresponding Global Variable
Agitation High High (RPM)	38.000	If the PV is above this value, the alarm state is "warning."	✓	Limits.Agitation High High (RPM)
Temp Low Low (C)	35.000	If the PV is below this value, the alarm state is "error."	✓	Limits.Temp Low Low (C)
Temp Low (C)	36.000	If the PV is below this value, the alarm state is "warning."	✓	Limits.Temp Low (C)
Temp High (C)	38.000	If the PV is above this value, the alarm state is "warning."	✓	Limits.Temp High (C)
Temp High High (C)	39.000	If the PV is above this value, the alarm state is "warning."	✓	Limits.Temp High High (C)
DO Low Low (%)	30.000	If the PV is below this value, the alarm state is "error."	✓	Limits.DO Low Low (%)
DO Low (%)	40.000	If the PV is below this value, the alarm state is "warning."	✓	Limits.DO Low (%)
DO High (%)	60.000	If the PV is above this value, the alarm state is "warning."	✓	Limits.DO High (%)
DO High High (%)	70.000	If the PV is above this value, the alarm state is "warning."	✓	Limits.DO High High (%)
pH Low Low	7.100	If the PV is below this value, the alarm state is "error."	✓	Limits.pH Low Low
pH Low	7.150	If the PV is below this value, the alarm state is "warning."	✓	Limits.pH Low
pH High	7.250	If the PV is above this value, the alarm state is "warning."	✓	Limits.pH High
pH High High	7.300	If the PV is above this value, the alarm state is "warning."	✓	Limits.pH High High

PROCESS ALARMS (continued)

Setting Name	Default Value	Definition	User May Change	Corresponding Global Variable
Level Low Low (L)	0.500	If the PV is below this value, the alarm state is "error."	✓	Limits.Level Low Low (L)
Level Low (L)	1.300	If the PV is below this value, the alarm state is "warning."	✓	Limits.Level Low (L)
Level High (L)	3.250	If the PV is above this value, the alarm state is "warning."	✓	Limits.Level High (L)
Level High High (L)	3.500	If the PV is above this value, the alarm state is "warning."	✓	Limits.Level High High (L)
Filter Oven Low Low (C)	33.000	If the PV is below this value, the alarm state is "error."	✓	Limits.Filter Oven Low Low (C)
Filter Oven Low (C)	35.000	If the PV is below this value, the alarm state is "warning."	✓	Limits.Filter Oven Low (C)
Filter Oven High (C)	41.000	If the PV is above this value, the alarm state is "warning."	✓	Limits.Filter Oven High (C)
Filter Oven High High (C)	43.000	If the PV is above this value, the alarm state is "warning."	✓	Limits.Filter Oven High High (C)
Main Gas Low Low (LPM)	0.050	If the PV is below this value, the alarm state is "error."	✓	Limits.Main Gas Low Low (LPM)
Main Gas Low (LPM)	0.100	If the PV is below this value, the alarm state is "warning."	✓	Limits.Main Gas Low (LPM)
Main Gas High (LPM)	0.400	If the PV is above this value, the alarm state is "warning."	✓	Limits.Main Gas High (LPM)
Main Gas High High (LPM)	0.450	If the PV is above this value, the alarm state is "warning."	✓	Limits.Main Gas High High (LPM)

SYSTEM

Setting Name	Default Value	Definition	User May Change	Corresponding Global Variable
Max Data Log Interval (min)	60.000	This is the maximum time that will elapse between the logging of two subsequent timepoints of a logged variable. This is in addition to the logging by deadband as configured in the logger settings file.	✓	LoggerMaxLog Interval(ms)
Alarm Snooze Time (s)	300.000	If a Process Alarm is audible, acknowledging the alarm will silence the buzzer for the given period of time.	✓	AlarmSnooze Time(ms)
Available Mem Limit (KB)	2000	If available memory on the RIO computer is less than this value, the “RT Mem Nearly Full” alarm is triggered.	X	SysAvailableMem Limit(KB)
LCB Mem Limit (KB)	2000	If available LCB on the RIO is less than this value, the “RT Mem Fragmented” alarm is triggered.	X	SysLCBMemLimit (KB)

Alarms Definitions

Group	Alarm Name	Alarm is Triggered When:
Agitation	Agitation Low Low	Agitation PV drops below this value.
Agitation	Agitation Low	Agitation PV drops below this value.
Agitation	Agitation High	Agitation PV rises above this value.
Agitation	Agitation High High	Agitation PV rises above this value.
Temperature	Temperature Low Low	Temperature PV drops below this value.
Temperature	Temperature Low	Temperature PV drops below this value.
Temperature	Temperature High	Temperature PV rises above this value.
Temperature	Temperature High High	Temperature PV rises above this value.
DO	DO Low Low	DO PV drops below this value.
DO	DO Low	DO PV drops below this value.
DO	DO High	DO PV rises above this value.
DO	DO High High	DO PV rises above this value.
pH	pH Low Low	pH PV drops below this value.
pH	pH Low	pH PV drops below this value.
pH	pH High	pH PV rises above this value.
pH	pH High High	pH PV rises above this value.
Level	Level Low Low	Level PV drops below this value.
Level	Level Low	Level PV drops below this value.
Level	Level High	Level PV rises above this value.
Level	Level High High	Level PV rises above this value.
Filter Oven	Filter Oven Low Low	Filter oven temperature PV drops below this value.
Filter Oven	Filter Oven Low	Filter oven temperature PV drops below this value.
Filter Oven	Filter Oven High	Filter oven temperature PV rises above this value.
Filter Oven	Filter Oven High High	Filter oven temperature PV rises above this value.

Group	Alarm Name	Alarm is Triggered When:
Main Gas	Main Gas Low Low	Main gas flow drops below this value.
Main Gas	Main Gas Low	Main gas flow drops below this value.
Main Gas	Main Gas High	Main gas flow rises above this value.
Main Gas	Main Gas High High	Main gas flow rises above this value.
System	Sequence Resumed	The RIO lost power while a sequence was running, and attempted to restart the sequence when it booted up.
Gas Flow	Air Source Pressure Error	The voltage corresponding to the flow rate being delivered by the Air MFC differs from the voltage corresponding to the flow rate being requested of the Air MFC by the Gas Data "Mismatch Thresh (V)" setting. Usually caused by a tank being empty, but could also be from the source pressure being too high.
Gas Flow	CO2 Source Pressure Error	The voltage corresponding to the flow rate being delivered by the CO ₂ MFC differs from the voltage corresponding to the flow rate being requested of the CO ₂ MFC by the Gas Data "Mismatch Thresh (V)" setting. Usually caused by a tank being empty, but could also be from the source pressure being too high.
Gas Flow	N2 Source Pressure Error	The voltage corresponding to the flow rate being delivered by the N ₂ MFC differs from the voltage corresponding to the flow rate being requested of the N ₂ MFC by the Gas Data "Mismatch Thresh (V)" setting. Usually caused by a tank being empty, but could also be from the source pressure being too high.
Gas Flow	O2 Source Pressure Error	The voltage corresponding to the flow rate being delivered by the O ₂ MFC differs from the voltage corresponding to the flow rate being requested of the O ₂ MFC by the Gas Data "Mismatch Thresh (V)" setting. Usually caused by a tank being empty, but could also be from the source pressure being too high.
Agitation	Agitation Sensor Failure	The agitation motor is being powered but agitation PV = 0 RPM.

Group	Alarm Name	Alarm is Triggered When:
Temperature	Temp Sensor A Failure (range)	Temperature sensor A registers a measurement above the Temperature “Valid High (C)” or below the Temperature “Valid Low (C)” settings.
DO	DO Sensor A Failure (range)	DO sensor A registers a measurement above the DO “Valid High (DO%)” or below the DO “Valid Low (DO%)” settings.
pH	pH Sensor A Failure (range)	pH sensor A registers a measurement above the pH “Valid High (pH)” or below the pH “Valid Low (pH)” settings.
pH	pH Sensor A Failure (rate)	pH sensor A registers a change in measurements greater than or equal to the pH “Rate Fail Delta PV” value over the pH “Rate Fail Delta Time (s)” time period.
System	Dirty Startup	RIO was restarted using a method other than through the Hello UI (usually just unplugging the bioreactor), and there was a problem recovering the last user-selected modes, set points etc. If this alarm was triggered, generate an errors report spanning the time this alarm was generated for more detailed information.
System	Clean Startup	RIO was restarted through the Hello UI.
System	Resume	RIO was restarted using a method other than through the Hello UI (usually just unplugging the bioreactor), but the last user-selected modes, set points etc. were recovered with no problems.
System	RT Mem Fragmented*	The largest contiguous block (LCB) of memory on the RIO computer is less than the System “LCB Mem Limit (KB)”.
System	RT Mem Nearly Full	The available memory on the RIO computer is less than the System “Available Mem Limit (KB)”.
Hardware Fault	NI 9205 Error*	Analog Input errors reading MFCs, DO, and pH.
Hardware Fault	NI 9425 Onboard Error	Digital Input errors reading leak sensor (N/A on PBS-3 SUS), pressure sensor connected (N/A on PBS-3 SUS), Door Pressure sensor (N/A on PBS-3 SUS), fuses, and RPM sensor. Digital Output errors writing to motor brake, media pump, and RTOS Run Status light.

Group	Alarm Name	Alarm is Triggered When:
Hardware Fault	NI 9219 Error	Error reading 9219 board (analog inputs for pressure sensor (N/A on PBS-3 SUS), load cell, and temperature sensors).
Hardware Fault	NI 9476 Error	Digital Output errors writing to temperature and filter oven heaters, door unlock (N/A on PBS-3 SUS, buzzer, sample pump, media pump, LED, addition pump A, addition pump B, and PBS 3 MAG agitation motor.
Hardware Fault	12 Vdc Atom Fuse*	This fuse needs to be replaced.
Hardware Fault	12 Vdc Mezz Fuse*	This fuse needs to be replaced.
Hardware Fault	12 Vdc Mntr Fuse*	This fuse needs to be replaced.
Hardware Fault	12 Vdc User1 Fuse*	This fuse needs to be replaced.
Hardware Fault	12 Vdc User2 Fuse	This fuse needs to be replaced.
Hardware Fault	12 Vdc User3 Fuse	This fuse needs to be replaced.
Hardware Fault	24 Vdc Fill Pump Fuse	This fuse needs to be replaced.
Hardware Fault	24 Vdc Ind DO Fuse*	This fuse needs to be replaced.
Hardware Fault	24 Vdc Main Fuse*	This fuse needs to be replaced.
Hardware Fault	24 Vdc Mezz Fuse*	This fuse needs to be replaced.
Hardware Fault	24 Vdc MFC Fuse*	This fuse needs to be replaced.
Hardware Fault	24 Vdc sbRIO Fuse*	This fuse needs to be replaced.
Hardware Fault	24 Vdc User1 Fuse*	This fuse needs to be replaced.
Hardware Fault	24 Vdc User2 Fuse	This fuse needs to be replaced.
Hardware Fault	24 Vdc User3 Fuse	This fuse needs to be replaced.
Hardware Fault	12 Vdc Supply Fuse†	This fuse needs to be replaced.

Group	Alarm Name	Alarm is Triggered When:
Hardware Fault	24 Vdc Supply Fuse†	This fuse needs to be replaced.
Hardware Fault	Pump Supply Fuse†	This fuse needs to be replaced.
Hardware Fault	24 Vdc Ctrl Main Fuse†	This fuse needs to be replaced.

* These alarms are only applicable to bioreactors with sbRIO model 9641 or 9642 (as visible in the Hello UI About menu). If these alarms are not applicable to your bioreactor, they will not appear in the Alarms Editor.

† These alarms are only applicable to bioreactors with sbRIO model 9603 (as visible in the Hello UI About menu). If these alarms are not applicable to your bioreactor, they will not appear in the Alarms Editor.

Default Alarms Configurations

The PBS-3 SUS comes with two default Alarms.alm files on the HMI. PBS Biotech Technical Support recommends loading the Alarms Inactive.alm file when you are not running a process, and before storing. It is configured to not notify about the alarms which would otherwise be triggered. PBS Biotech Technical Support recommends loading the Alarms On.alm file during a run. For more information, see “Configuring Alarm Settings” on page 55.

Group	Alarm Name	Alarms Inactive			Alarms On		
		Notify	Audible	Email	Notify	Audible	Email
Agitation	Agitation Low Low				✓	✓	✓
Agitation	Agitation Low				✓		
Agitation	Agitation High				✓		
Agitation	Agitation High High				✓	✓	✓
Temperature	Temperature Low Low				✓	✓	✓
Temperature	Temperature Low				✓		
Temperature	Temperature High	✓			✓		
Temperature	Temperature High High	✓		✓	✓	✓	✓
DO	DO Low Low				✓	✓	✓
DO	DO Low				✓		
DO	DO High				✓		
DO	DO High High				✓	✓	✓
pH	pH Low Low				✓	✓	✓
pH	pH Low				✓		
pH	pH High				✓		
pH	pH High High				✓	✓	✓
Level	Level Low Low				✓	✓	✓
Level	Level Low				✓		
Level	Level High				✓		

Appendix 3 - Default Alarms Configurations

Group	Alarm Name	Alarms Inactive			Alarms On		
		Notify	Audible	Email	Notify	Audible	Email
Level	Level High High				✓	✓	✓
Filter Oven	Filter Oven Low Low				✓	✓	✓
Filter Oven	Filter Oven Low				✓		
Filter Oven	Filter Oven High	✓			✓		
Filter Oven	Filter Oven High High	✓			✓	✓	
Main Gas	Main Gas Low Low				✓	✓	✓
Main Gas	Main Gas Low				✓		
Main Gas	Main Gas High	✓			✓		
Main Gas	Main Gas High High	✓		✓	✓	✓	✓
System	Sequence Resumed	✓		✓	✓		✓
Gas Flow	Air Source Pressure Error	✓		✓	✓	✓	✓
Gas Flow	CO2 Source Pressure Error	✓		✓	✓	✓	✓
Gas Flow	N2 Source Pressure Error	✓		✓	✓	✓	✓
Gas Flow	O2 Source Pressure Error	✓		✓	✓	✓	✓
Agitation	Agitation Sensor Failure	✓		✓	✓	✓	✓
Temperature	Temp Sensor A Failure (range)	✓		✓	✓	✓	✓
DO	DO Sensor A Failure (range)				✓	✓	✓
pH	pH Sensor A Failure (range)				✓	✓	✓

Appendix 3 - Default Alarms Configurations

Group	Alarm Name	Alarms Inactive			Alarms On		
		Notify	Audible	Email	Notify	Audible	Email
pH	pH Sensor A Failure (rate)				✓	✓	✓
System	Dirty Startup	✓			✓		
System	Clean Startup	✓			✓		
System	Resume	✓			✓		
System	RT Mem Fragmented*	✓		✓	✓		✓
System	RT Mem Nearly Full	✓		✓	✓		✓
Hardware Fault	NI 9205 Error*	✓		✓	✓		✓
Hardware Fault	NI 9425 Onboard Error	✓		✓	✓		✓
Hardware Fault	NI 9219 Error	✓		✓	✓		✓
Hardware Fault	NI 9476 Error	✓		✓	✓		✓
Hardware Fault	12 Vdc Atom Fuse*	✓			✓		
Hardware Fault	12 Vdc Mezz Fuse*	✓			✓		
Hardware Fault	12 Vdc Mntr Fuse*	✓			✓		
Hardware Fault	12 Vdc User1 Fuse*	✓			✓		
Hardware Fault	12 Vdc User2 Fuse	✓			✓		
Hardware Fault	12 Vdc User3 Fuse	✓			✓		
Hardware Fault	24 Vdc Fill Pump Fuse	✓			✓		
Hardware Fault	24 Vdc Ind DO Fuse*	✓			✓		
Hardware Fault	24 Vdc Main Fuse*	✓			✓		

Group	Alarm Name	Alarms Inactive			Alarms On		
		Notify	Audible	Email	Notify	Audible	Email
Hardware Fault	24 Vdc Mezz Fuse*	✓			✓		
Hardware Fault	24 Vdc MFC Fuse*	✓			✓		
Hardware Fault	24 Vdc sbRIO Fuse*	✓			✓		
Hardware Fault	24 Vdc User1 Fuse*	✓			✓		
Hardware Fault	24 Vdc User2 Fuse	✓			✓		
Hardware Fault	24 Vdc User3 Fuse	✓			✓		
Hardware Fault	12 Vdc Supply Fuse†	✓			✓		
Hardware Fault	24 Vdc Supply Fuse†	✓			✓		
Hardware Fault	Pump Supply Fuse†	✓			✓		
Hardware Fault	24 Vdc Ctrl Main Fuse†	✓			✓		

* These alarms are only applicable to bioreactors with sbRIO model 9641 or 9642 (as visible in the Hello UI About menu). If these alarms are not applicable to your bioreactor, they will not appear in the Alarms Editor.

† These alarms are only applicable to bioreactors with sbRIO model 9603 (as visible in the Hello UI About menu). If these alarms are not applicable to your bioreactor, they will not appear in the Alarms Editor.

Default Logger Configurations and Global Variables Definitions

The PBS-3 SUS ships with a default Logger file loaded. For more information, see “Configuring Logger Settings” on page 52.

AGITATION

Variable Name	Default Deadband	Default Record	Source	Definition
AgPV(RPM)	0.500	✓	Calc	The speed of the wheel detected by the software.
AgSP(RPM)	0.500	✓	User	The last agitation set point used when agitation was in Auto mode.
AgPowerUser(%)	0.100	✓	User	The last user-defined power output used when agitation was in Manual mode.
AgModeActual	0.500	✓	Calc	The actual agitation mode: 0) Auto, 1) Manual, 2) Off, 3) Lookup, and 4) Pulse.
AgModeUser	0.500		User	The user-requested agitation mode: 0) Auto, 1) Manual, and 2) Off.
AgPowerActualRequest(%)	2.000	✓	Calc	The % power being sent to the agitation motor.
AgPowerControl.PGain (%/RPM)	0.010		System	See Agitation “P Gain (%/RPM)” setting in Appendix 1.
AgPowerControl.ITime (min)	0.010		System	See Agitation “I Time (min)” setting in Appendix 1.
AgPowerControl.DTime (min)	0.010		System	See Agitation “D Time (min)” setting in Appendix 1.
AgControlAlpha	0.001		System	See Agitation “Alpha” setting in Appendix 1.
AgControlBeta	0.001		System	See Agitation “Beta” setting in Appendix 1.

AGITATION (continued)

Variable Name	Default Deadband	Default Record	Source	Definition
AgControlGamma	0.001		System	See Agitation “Gamma” setting in Appendix 1.
AgControlLinearity	0.001		System	See Agitation “Linearity” setting in Appendix 1.
AgAutoMaxStartup(%)	0.001		System	See Agitation “Auto Max Startup (%)” setting in Appendix 1.
AgLookupModeTimeout (ms)	0.001		System	See Agitation “Lookup Mode Timeout (s)” setting in Appendix 1.
AgMin(RPM)	0.001		System	See Agitation “Minimum (RPM)” setting in Appendix 1.
AgMinPower(%)	0.001		System	See Safety “Min Ag Power (%)” setting in Appendix 1.
AgPowerRangeAuto (%).Max	0.010		System	See Agitation “Power Auto Max (%)” setting in Appendix 1.
AgPowerRangeAuto (%).Min	0.010		System	See Agitation “Power Auto Min (%)” setting in Appendix 1.
AgPowerRangeManMax (%)	0.010		System	See Agitation “Power Manual Max (%)” setting in Appendix 1.
AgPulseModeTimeout(ms)	1.000		System	See Agitation “Pulse Mode Timeout (s)” setting in Appendix 1.
AgPwrLookupFactor (%/RPM)	0.001		System	See Agitation “Lookup Factor (%/RPM)” setting in Appendix 1.
AgWheelMagnetCount	0.500		System	See Agitation “Number of Magnets” setting in Appendix 1.
AgWheelSamplesTo Average	0.500		System	See Agitation “Samples To Average” setting in Appendix 1.

ALARM

Variable Name	Default Deadband	Default Record	Source	Definition
AlarmBuzzerUser	0.500		User	True when the user wants to test the buzzer.
AlarmBuzzerPeriod(Cycle)	10.000		System	See Safety “Buzzer Period (ms)” setting in Appendix 1.
AlarmFuseStatus	0.500		Sensor	Status of the fuses – when the number is above zero it means at least 1 fuse is blown.
AlarmSnoozeTime(ms)	1.000		System	See System “Alarm Snooze Time (s)” setting in Appendix 1.

PROCESS ALARMS/LIMITS

Variable Name	Default Deadband	Default Record	Source	Definition
SensorStates.Agitation	0.500		Calc	The state of the sensor with regard to Process Alarms and failures: 1) In Range, 2) Above High, 3) Below Low, 4) Above High High, 5) Below Low Low, and 6) Sensor Error Mode.
SensorStates.DO	0.500		Calc	The state of the sensor with regard to Process Alarms and failures: 1) In Range, 2) Above High, 3) Below Low, 4) Above High High, 5) Below Low Low, and 6) Sensor Error Mode.
SensorStates.Filter Oven	0.500		Calc	The state of the sensor with regard to Process Alarms and failures: 1) In Range, 2) Above High, 3) Below Low, 4) Above High High, 5) Below Low Low, and 6) Sensor Error Mode.

PROCESS ALARMS/LIMITS (continued)

Variable Name	Default Deadband	Default Record	Source	Definition
SensorStates.Level	0.500		Calc	The state of the sensor with regard to Process Alarms and failures: 1) In Range, 2) Above High, 3) Below Low, 4) Above High High, and 5) Below Low Low.
SensorStates.Main Gas	0.500		Calc	The state of the sensor with regard to Process Alarms and failures: 1) In Range, 2) Above High, 3) Below Low, 4) Above High High, and 5) Below Low Low.
SensorStates.Temperature	0.500		Calc	The state of the sensor with regard to Process Alarms and failures: 1) In Range, 2) Above High, 3) Below Low, 4) Above High High, 5) Below Low Low, and 6) Sensor Error Mode.
SensorStates.pH	0.500		Calc	The state of the sensor with regard to Process Alarms and failures: 1) In Range, 2) Above High, 3) Below Low, 4) Above High High, 5) Below Low Low, and 6) Sensor Error Mode.
Limits.Agitation Low Low (RPM)	0.001		System	See Process Alarms "Agitation Low Low (RPM)" setting in Appendix 1.
Limits.Agitation Low (RPM)	0.001		System	See Process Alarms "Agitation Low (RPM)" setting in Appendix 1.
Limits.Agitation High (RPM)	0.001		System	See Process Alarms "Agitation High (RPM)" setting in Appendix 1.

PROCESS ALARMS/LIMITS (continued)

Variable Name	Default Deadband	Default Record	Source	Definition
Limits.Agitation High High (RPM)	0.001		System	See Process Alarms “Agitation High High (RPM)” setting in Appendix 1.
Limits.DO Low Low (%)	0.001		System	See Process Alarms “DO Low Low (%)” setting in Appendix 1.
Limits.DO Low (%)	0.001		System	See Process Alarms “DO Low (%)” setting in Appendix 1.
Limits.DO High (%)	0.001		System	See Process Alarms “DO High (%)” setting in Appendix 1.
Limits.DO High High (%)	0.001		System	See Process Alarms “DO High High (%)” setting in Appendix 1.
Limits.Filter Oven Low Low (C)	0.001		System	See Process Alarms “Filter Oven Low Low (C)” setting in Appendix 1.
Limits.Filter Oven Low (C)	0.001		System	See Process Alarms “Filter Oven Low (C)” setting in Appendix 1.
Limits.Filter Oven High (C)	0.001		System	See Process Alarms “Filter Oven High (C)” setting in Appendix 1.
Limits.Filter Oven High High (C)	0.001		System	See Process Alarms “Filter Oven High High (C)” setting in Appendix 1.
Limits.Level Low Low (L)	0.001		System	See Process Alarms “Level Low Low (L)” setting in Appendix 1.
Limits.Level Low (L)	0.001		System	See Process Alarms “Level Low (L)” setting in Appendix 1.

PROCESS ALARMS/LIMITS (continued)

Variable Name	Default Deadband	Default Record	Source	Definition
Limits.Level High (L)	0.001		System	See Process Alarms “Level High (L)” setting in Appendix 1.
Limits.Level High High (L)	0.001		System	See Process Alarms “Level High High (L)” setting in Appendix 1.
Limits.Main Gas Low Low (LPM)	0.001		System	See Process Alarms “Main Gas Low Low (LPM)” setting in Appendix 1.
Limits.Main Gas Low (LPM)	0.001		System	See Process Alarms “Main Gas Low (LPM)” setting in Appendix 1.
Limits.Main Gas High (LPM)	0.001		System	See Process Alarms “Main Gas High (LPM)” setting in Appendix 1.
Limits.Main Gas High High (LPM)	0.001		System	See Process Alarms “Main Gas High High (LPM)” setting in Appendix 1.
Limits.Temp Low Low (C)	0.001		System	See Process Alarms “Temp Low Low (C)” setting in Appendix 1.
Limits.Temp Low (C)	0.001		System	See Process Alarms “Temp Low (C)” setting in Appendix 1.
Limits.Temp High (C)	0.001		System	See Process Alarms “Temp High (C)” setting in Appendix 1.
Limits.Temp High High (C)	0.001		System	See Process Alarms “Temp High High (C)” setting in Appendix 1.
Limits.pH Low Low	0.001		System	See Process Alarms “pH Low Low” setting in Appendix 1.
Limits.pH Low	0.001		System	See Process Alarms “pH Low” setting in Appendix 1.

PROCESS ALARMS/LIMITS (continued)

Variable Name	Default Deadband	Default Record	Source	Definition
Limits.pH High	0.001		System	See Process Alarms “pH High” setting in Appendix 1.
Limits.pH High High	0.001		System	See Process Alarms “pH High High” setting in Appendix 1.

CALIBRATION

Variable Name	Default Deadband	Default Record	Source	Definition
CalpHA.Slope	0.010		System	The slope of the raw voltage to pH sensor A PV conversion.
CalpHA.Offset(%)	0.010		System	The offset of the raw voltage to pH sensor A PV conversion.
CalpHA.Temp(C)	0.010		System	The temperature at which pH sensor A was calibrated.
CalDOA.Slope	0.010		System	The slope of the raw voltage to DO sensor A PV conversion.
CalDOA.Offset(%)	0.010		System	The offset of the raw voltage to DO sensor A PV conversion.
CalLevel.m	0.010		System	The slope of the raw voltage to level PV conversion.
CalLevel.b	0.010		System	The offset of the raw voltage to level PV conversion.
CalTempA.Slope	0.010		System	The slope of the raw resistance to temperature sensor A PV conversion.

CALIBRATION (continued)

Variable Name	Default Deadband	Default Record	Source	Definition
CalTempA.Offset(C)	0.010		System	The offset of the raw resistance to temperature sensor A PV conversion.
CalFilterOvenTemp.Slope	0.010		System	The slope of the raw resistance to filter oven temperature PV conversion.
CalFilterOvenTemp.Offset (C)	0.010		System	The offset for the raw resistance to filter oven temperature PV conversion.
CalMFCAir.m(LPM/V)	0.001		System	The slope of the raw voltage to Air flow (LPM) output conversion.
CalMFCAir.b(LPM)	0.001		System	The offset of the raw voltage to Air flow (LPM) output conversion.
CalMFCCO2.m(LPM/V)	0.001		System	The slope of the raw voltage to CO ₂ flow (LPM) output conversion.
CalMFCCO2.b(LPM)	0.001		System	The offset of the raw voltage to CO ₂ flow (LPM) output conversion.
CalMFCN2.m(LPM/V)	0.001		System	The slope of the raw voltage to N ₂ flow (LPM) output conversion.
CalMFCN2.b(LPM)	0.001		System	The offset of the raw voltage to N ₂ flow (LPM) output conversion.
CalMFCO2.m(LPM/V)	0.001		System	The slope of the raw voltage to O ₂ flow (LPM) output conversion.
CalMFCO2.b(LPM)	0.001		System	The offset of the raw voltage to O ₂ flow (LPM) output conversion.

CALIBRATION (continued)

Variable Name	Default Deadband	Default Record	Source	Definition
CalLimitsLevel.CallLevel InterceptMax(psi)	0.001		System	See Level “CallLevel InterceptMax(psi)” setting in Appendix 1.
CalLimitsLevel.CallLevel InterceptMin(psi)	0.001		System	See Level “CallLevel InterceptMin(psi)” setting in Appendix 1.
CalLimitsLevel.CallLevel SlopeMax(psi/V)	0.001		System	See Level “CallLevel SlopeMax(psi/V)” setting in Appendix 1.
CalLimitsLevel.CallLevel SlopeMin(psi/V)	0.001		System	See Level “CallLevel SlopeMin(psi/V)” setting in Appendix 1.

DO

Variable Name	Default Deadband	Default Record	Source	Definition
DOPV(%)	2.000	✓	Calc	The DO value detected by the software.
DOSP(%)	1.000	✓	User	The last DO set point used when DO was in Auto mode.
DON2FlowUser(%)	1.000	✓	User	The last user-defined N ₂ output used when DO was in Manual mode.
DOO2FlowUser(%)	0.100	✓	User	The last user-defined O ₂ output used when DO was in Manual mode.
DOModeActual	0.500	✓	Calc	The actual DO mode: 0) Auto, 1) Manual, 2) Off, and 3) Sensor Error.
DOModeUser	0.500		User	The user-requested DO mode: 0) Auto, 1) Manual, and 2) Off.

DO (continued)

Variable Name	Default Deadband	Default Record	Source	Definition
DOO2FlowController RequestLimited(%)	2.000	✓	Calc	The O ₂ flow output the software actually requests from the O ₂ MFC, in percent of main gas flow. It limits the O ₂ flow the DO controller requests by taking the maximum O ₂ MFC flow, the Gas Data “O ₂ Min Volume (L)” setting, and the requested CO ₂ flow into account.
DON2FlowActualRequest (%)	2.000	✓	Calc	The N ₂ flow output the software actually requests from the N ₂ MFC, in percent of main gas flow. It limits the N ₂ flow the DO controller requests by taking the maximum N ₂ MFC flow, the CO ₂ flow request, and the O ₂ flow request into account.
DOA(%)	2.000		Calc	The PV reported by DO sensor A.
DOARaw(%)	0.100		Sensor	The raw voltage DO sensor A reports.
DOAisActive	0.500		Calc	True when DO sensor A is not failed.
DOInRange.A	0.500		Calc	True when DO sensor A is in valid range.
DOO2FlowController Request(%)	2.000		Calc	The O ₂ flow output requested by the DO controller, in percent of main gas flow.
DON2FlowController Request(%)	2.000		Calc	The N ₂ flow output requested by the DO controller, in percent of main gas flow.

DO (continued)

Variable Name	Default Deadband	Default Record	Source	Definition
DOO2FlowController RequestLimited(mLPM)	5.000		Calc	The O ₂ flow output the software actually requests from the O ₂ MFC, in mL/min. It limits the O ₂ flow the DO controller requests by taking the maximum O ₂ MFC flow, the Gas Data “O ₂ Min Volume (L)” setting, and the requested CO ₂ flow into account.
DODeadband(%)	0.001	✓	System	See DO “Deadband (DO%)” setting in Appendix 1.
DON2Control.PGain(%/%)	0.001		System	See DO “N2 P Gain (%/DO%)” setting in Appendix 1.
DON2Control.ITime(min)	0.001		System	See DO “N2 I Time (min)” setting in Appendix 1.
DON2Control.DTime(min)	0.001		System	See DO “N2 D Time (min)” setting in Appendix 1.
DON2ControlAlpha	0.001		System	See DO “N2 Alpha” setting in Appendix 1.
DON2ControlBeta	0.001		System	See DO “N2 Beta” setting in Appendix 1.
DON2ControlGamma	0.001		System	See DO “N2 Gamma” setting in Appendix 1.
DON2ControlLinearity	0.001		System	See DO “N2 Linearity” setting in Appendix 1.
DON2RangeAutoMax(%)	0.001		System	See DO “N2 Auto Max (%)” setting in Appendix 1.
DON2RangeManMax(%)	0.001		System	See DO “N2 Manual Max (%)” setting in Appendix 1.

DO (continued)

Variable Name	Default Deadband	Default Record	Source	Definition
DOO2ControlMag.PGain (%/%)	0.001		System	See DO “O2 P Gain (%/DO%)” setting in Appendix 1.
DOO2ControlMag.ITime (min)	0.001		System	See DO “O2 I Time (min)” setting in Appendix 1.
DOO2ControlMag.DTime (min)	0.001		System	See DO “O2 D Time (min)” setting in Appendix 1.
DOO2ControlAlpha	0.001		System	See DO “O2 Alpha” setting in Appendix 1.
DOO2ControlBeta	0.001		System	See DO “O2 Beta” setting in Appendix 1.
DOO2ControlGamma	0.001		System	See DO “O2 Gamma” setting in Appendix 1.
DOO2ControlLinearity	0.001		System	See DO “O2 Linearity” setting in Appendix 1.
DOO2RangeAutoMax(%)	1.000		System	See DO “O2 Auto Max (%)” setting in Appendix 1.
DOO2RangeManMax(%)	0.001		System	See DO “O2 Manual Max (%)” setting in Appendix 1.
DOValidMax(%)	0.001		System	See DO “Valid High (DO%)” setting in Appendix 1.
DOValidMin(%)	0.001		System	See DO “Valid Low (DO%)” setting in Appendix 1.

FILTER OVEN

Variable Name	Default Deadband	Default Record	Source	Definition
FilterOvenPV(C)	5.000	✓	Calc	The temperature of the filter oven detected by the software.

FILTER OVEN (continued)

Variable Name	Default Deadband	Default Record	Source	Definition
FilterOvenSP(C)	1.000	✓	User	The last filter oven set point used when filter oven was in Auto mode.
FilterOvenDutyUser(%)	1.000	✓	User	The last user-defined heater duty used when filter oven was in Manual mode.
FilterOvenModeActual	0.500	✓	Calc	The actual filter oven mode: 0) Auto, 1) Manual, 2) Off, and 3) Sensor Error.
FilterOvenModeUser	0.500		User	The user-requested filter oven mode: 0) Auto, 1) Manual, and 2) Off.
FilterOvenDutyActual(%)	50.000	✓	Calc	The heater duty of the filter oven.
FilterOvenRaw(C)	5.000		Sensor	The raw resistance the filter oven sensor reports.
FilterOvenSensorActive	0.500		Calc	True when the filter oven temperature sensor has not failed.
FilterOvenDuty Control.Gain(%/C)	0.001		System	See Filter Oven “P Gain (%/C)” setting in Appendix 1.
FilterOvenDuty Control.ITime(min)	0.001		System	See Filter Oven “I Time (min)” setting in Appendix 1.
FilterOvenDuty Control.DTime(min)	0.001		System	See Filter Oven “D Time (min)” setting in Appendix 1.
FilterOvenDutyControl Alpha	0.001		System	See Filter Oven “Alpha” setting in Appendix 1.
FilterOvenDutyControlBeta	0.001		System	See Filter Oven “Beta” setting in Appendix 1.
FilterOvenDutyControl Gamma	0.001		System	See Filter Oven “Gamma” setting in Appendix 1.

FILTER OVEN (continued)

Variable Name	Default Deadband	Default Record	Source	Definition
FilterOvenDutyControl Linearity	0.001		System	See Filter Oven “Linearity” setting in Appendix 1.
FilterOvenDutyRangeAuto Max(%)	0.001		System	See Filter Oven “Heat Auto Max (%)” setting in Appendix 1.
FilterOvenDutyRangeMan Max(%)	0.001		System	See Filter Oven “Heat Manual Max (%)” setting in Appendix 1.

GASES

Variable Name	Default Deadband	Default Record	Source	Definition
MainGasFeedback(LPM)	0.100		Calc	The sum of the actual flows of the Air, N ₂ , CO ₂ , and O ₂ MFCs.
MainGasUser(LPM)	0.100	✓	User	The last user-defined flow rate used when main gas was in Manual mode.
MainGasModeActual	0.500	✓	Calc	The actual main gas mode: 0) Auto, 1) Manual, and 2) Off.
MainGasModeUser	0.500		User	The user-requested main gas mode: 0) Auto, 1) Manual, and 2) Off.
MainGasActualRequest (LPM)	0.100	✓	Calc	The gas flow output the controller requests of the main gas MFCs.
MFCAirFlowFeedback (LPM)	0.025	✓	Calc	The voltage feedback from the Air MFC converted to a flow rate with its slope and offset, representing the actual flow out of the Air MFC.

GASES (continued)

Variable Name	Default Deadband	Default Record	Source	Definition
MFCO2FlowFeedback (LPM)	0.035	✓	Calc	The voltage feedback from the CO ₂ MFC converted to a flow rate with its slope and offset, representing the actual flow out of the CO ₂ MFC.
MFCN2FlowFeedback (LPM)	0.025	✓	Calc	The voltage feedback from the N ₂ MFC converted to a flow rate with its slope and offset, representing the actual flow out of the N ₂ MFC.
MFCO2FlowFeedback (LPM)	0.025	✓	Calc	The voltage feedback from the O ₂ MFC converted to a flow rate with its slope and offset, representing the actual flow out of the O ₂ MFC.
MFCAirMeasRaw(V)	0.100		Sensor	The raw voltage the Air MFC reports.
MFCO2MeasRaw(V)	0.100		Sensor	The raw voltage the CO ₂ MFC reports.
MFCN2MeasRaw(V)	0.100		Sensor	The raw voltage the N ₂ MFC reports.
MFCO2MeasRaw(V)	0.100		Sensor	The raw voltage the O ₂ MFC reports.
MainGasRangeManMax (LPM)	0.001		System	See Gas Data “Manual Max (LPM)” setting in Appendix 1.
MFCAirMin(LPM)	0.001		System	See Gas Data “Air Min (LPM)” setting in Appendix 1.
MFCAirOff(V)	0.001		System	See Gas Data “Air Off (V)” setting in Appendix 1.
MFCO2Min(LPM)	0.001		System	See Gas Data “CO ₂ Min (LPM)” setting in Appendix 1.

GASES (continued)

Variable Name	Default Deadband	Default Record	Source	Definition
MFCO2Off(V)	0.001		System	See Gas Data “CO2 Off (V)” setting in Appendix 1.
MFCMaxPeriod(s)	0.001		System	See Gas Data “PWM Max Period (s)” setting in Appendix 1.
MFCMismatchThresh(V)	0.001		System	See Gas Data “Mismatch Thresh (V)” setting in Appendix 1.
MFCN2Min(LPM)	0.001		System	See Gas Data “N2 Min (LPM)” setting in Appendix 1.
MFCN2Off(V)	0.001		System	See Gas Data “N2 Off (V)” setting in Appendix 1.
MFCO2Min(LPM)	0.001		System	See Gas Data “O2 Min (LPM)” setting in Appendix 1.
MFCO2Off(V)	0.001		System	See Gas Data “O2 Off (V)” setting in Appendix 1.
MFCOnTime(s)	0.001		System	See Gas Data “PWM On Time (s)” setting in Appendix 1.
O2 Min Volume (L)	0.001		System	See Gas Data “O2 Min Volume (L)” setting in Appendix 1.

INTERLOCKS

Variable Name	Default Deadband	Default Record	Source	Definition
InterlockHeater	0.500		Calc	Indicates whether main heater will not turn on because temperature is interlocked.

INTERLOCKS (continued)

Variable Name	Default Deadband	Default Record	Source	Definition
InterlockPumps	0.500		Calc	Indicates whether media and additions pumps will not turn on because they are interlocked.
InterlockTempMax(C)	0.001		System	See Safety “Max Temp (C)” setting in Appendix 1.

LEDS

Variable Name	Default Deadband	Default Record	Source	Definition
LEDWhiteLEDOn	0.500		User	The user can set this to true to turn on the white light in the chamber.

LEVEL

Variable Name	Default Deadband	Default Record	Source	Definition
LevelPV(L)	0.100	✓	Calc	The level of the vessel contents detected by the software.
LevelRaw(V)	0.100		Sensor	The raw voltage the level sensor reports.
LevelCalCluster.Level Empty(V)	0.001		System	See Level “Empty Level (V)” setting in Appendix 1.
LevelMax(L)	0.001		System	See Safety “Max Level (L)” setting in Appendix 1.
LevelMin(L)	0.001		System	See Safety “Min Level (L)” setting in Appendix 1.
LevelSensorEnable	0.500		System	See Level “Enable Sensor (0 or 1)” setting in Appendix 1.

pH

Variable Name	Default Deadband	Default Record	Source	Definition
pHPV	0.050	✓	Calc	The pH value detected by the software.
pHSP	0.010	✓	User	The last pH set point used when pH was in Auto mode.
pHCO2User(%)	1.000	✓	User	The last user-defined CO ₂ output used when pH was in Manual mode.
pHBaseDutyUser(%)	1.000	✓	User	The last user-defined base pump output used when pH was in Manual mode.
pHModeActual	0.500	✓	Calc	The actual pH mode: 0) Auto, 1) Manual, 2) Off, and 3) Sensor Error.
pHModeUser	0.500		User	The user-requested pH mode: 0) Auto, 1) Manual, and 2) Off.
pHCO2ActualRequest(%)	1.000	✓	Calc	The CO ₂ flow output the software actually requests from the CO ₂ MFC, in percent of main gas flow. It limits the CO ₂ flow the pH controller requests by taking the maximum CO ₂ MFC flow and the requested main gas flow into account.
pHBaseDutyActual(%)	1.000	✓	Calc	The base pump output.
pHA	0.050		Calc	The PV reported by pH sensor A.
pHARaw	0.010		Sensor	The raw voltage pH sensor A reports.
pHAIsActive	0.500		Calc	True when pH sensor A has not failed.
pHInRange.A	0.500		Calc	True when pH sensor A is in valid range.

pH (continued)

Variable Name	Default Deadband	Default Record	Source	Definition
pHAUseTempComp	0.500		System	See pH “A Use Temp Comp?” setting in Appendix 1.
pHActiveMode	0.500		Calc	In Auto mode, indicates if the controller is: 0) lowering the pH, 1) in the deadband, or 2) raising pH.
pHCO2FlowController Request(%)	1.000		Calc	The CO ₂ flow output requested by the pH controller, in percent of main gas flow.
pHBaseDutyControl.PGain (%)	0.001		System	See pH “Base P Gain (%/pH)” setting in Appendix 1.
pHBaseDutyControl.ITime (min)	0.001		System	See pH “Base I Time (min)” setting in Appendix 1.
pHBaseDutyControl.DTime (min)	0.001		System	See pH “Base D Time (min)” setting in Appendix 1.
pHBaseDutyControlAlpha	0.001		System	See pH “Base Alpha” setting in Appendix 1.
pHBaseDutyControlBeta	0.001		System	See pH “Base Beta” setting in Appendix 1.
pHBaseDutyControl Gamma	0.001		System	See pH “Base Gamma” setting in Appendix 1.
pHBaseDutyControl Linearity	0.001		System	See pH “Base Linearity” setting in Appendix 1.
pHBaseDutyManMax(%)	0.001		System	See pH “Base Manual Max (%)” setting in Appendix 1.
pHBaseAutoMax	0.001		System	See pH “Base Auto Max (%)” setting in Appendix 1.
pHCO2Control.PGain(%)	0.001		System	See pH “CO ₂ P Gain (%/pH)” setting in Appendix 1.

pH (continued)

Variable Name	Default Deadband	Default Record	Source	Definition
pHCO2Control.ITime(min)	0.001		System	See pH “CO2 I Time (min)” setting in Appendix 1.
pHCO2Control.DTime(min)	0.001		System	See pH “CO2 D Time (min)” setting in Appendix 1.
pHCO2ControlAlpha	0.001		System	See pH “CO2 Alpha” setting in Appendix 1.
pHCO2ControlBeta	0.001		System	See pH “CO2 Beta” setting in Appendix 1.
pHCO2ControlGamma	0.001		System	See pH “CO2 Gamma” setting in Appendix 1.
pHCO2ControlLinearity	0.001		System	See pH “CO2 Linearity” setting in Appendix 1.
pHCO2ManMax(%)	0.001		System	See pH “CO2 Manual Max (%)” setting in Appendix 1.
pHCO2AutoMax(%)	0.001		System	See pH “CO2 Auto Max (%)” setting in Appendix 1.
pHDeadband	0.001	✓	System	See pH “Deadband” setting in Appendix 1.
pHRateFailDeltaPV	0.001		System	See pH “Rate Fail Delta PV” setting in Appendix 1.
pHRateFailDeltaTime(ms)	1.000		System	See pH “Rate Fail Delta Time (s)” setting in Appendix 1.
pHSensorSamplesTo Average	0.500		System	See pH “Samples To Average” setting in Appendix 1.
pHValidMax	0.001		System	See pH “Valid High (pH)” setting in Appendix 1.
pHValidMin	0.001		System	See pH “Valid Low (pH)” setting in Appendix 1.

PUMPS AND VALVES

Variable Name	Default Deadband	Default Record	Source	Definition
Pumps&ValvesFillSpeed (RPM)	0.500		User	For PBS Vertical-Wheel® Bioreactors with an RPM-controllable media pump, this is the speed at which the user wants the media pump to turn. For other models, a value of 0 means the media pump is off and a higher number means it is on.
Pumps&ValvesPumpUser1	0.500	✓	User	For PBS Vertical-Wheel® Bioreactors with speed-controllable addition pumps, this is the user-requested addition pump A speed: 0) Off, 1) Slow, 2) Medium, 3) Fast.
Pumps&ValvesPumpUser2	0.500	✓	User	For PBS Vertical-Wheel® Bioreactors with speed-controllable addition pumps, this is the user-requested addition pump B speed: 0) Off, 1) Slow, 2) Medium, 3) Fast.
Pumps&ValvesBasePump Selection	0.500	✓	User	The selector of which pump is the base pump: 0) No base pump selected, 1) addition pump A, or 2) addition pump B.
Pumps&ValvesPumpSmpl Req	0.500		User	The user sets this to true to request the sample pump to run.
Pumps&ValvesPumpSmpl RevrsReq	0.500		User	The user can toggle this to change pump direction.
Pumps&ValvesPumpSmpl	0.500		Calc	True when the Sample Pump is on.

PUMPS AND VALVES (continued)

Variable Name	Default Deadband	Default Record	Source	Definition
Pumps&ValvesPumpSmpl Revrs	0.500		Calc	This toggles the sample pump direction.
Pumps&Valves Pump1.Duty	1.000		Calc	The pulse-density modulation duty for addition pump A. 2 ¹⁶ would be 100% duty.
Pumps&Valves Pump2.Duty	1.000		Calc	The pulse-density modulation duty for addition pump B. 2 ¹⁶ would be 100% duty.
Pumps&ValvesPumpLow AuxSpeed	1.000		System	See Pumps “Aux Low Duty” setting in Appendix 1.
Pumps&ValvesPumpMed AuxSpeed	1.000		System	See Pumps “Aux Med Duty” setting in Appendix 1.
Pumps&ValvesBaseMax Period(s)	0.001		System	See Pumps “Base Max Period (s)” setting in Appendix 1.
Pumps&ValvesBaseOn Time(s)	0.001		System	See Pumps “Base On Time (s)” setting in Appendix 1.
Pumps&ValvesReverse CCandCW	0.500		System	See Pumps “Sample Reverse CW and CCW (0 or 1)” setting in Appendix 1.

SEQUENCE/RECIPE

Variable Name	Default Deadband	Default Record	Source	Definition
Recipe Index	0.500		Calc	The step the sequence is currently on. Value is -1 when no sequence is running, 0 for first step, 1 for second step, etc.

Appendix 4 - Default Logger Configurations and Global Variables Definitions

LOGGER

Variable Name	Default Deadband	Default Record	Source	Definition
LoggerMaxLogInterval(ms)	60.000		System	See System “Max Data Log Interval (min)” setting in Appendix 1.

SYSTEM

Variable Name	Default Deadband	Default Record	Source	Definition
SysAvailableMem(KB)	0.001		System	Available memory on the RIO computer (kilobytes).
SysAvailableMemLimit(KB)	0.001		System	See System “Available Mem Limit (KB)” setting in Appendix 1.
SysLCBMem(KB)	0.001		System	Size (kilobytes) of the largest contiguous block (LCB) of memory on the RIO computer.
SysLCBMemLimit(KB)	0.001		System	See System “LCB Mem Limit (KB)” setting in Appendix 1.
Sys_StartupCond	0.500		System	Outputs how the last shutdown of the RIO computer occurred. Used to trigger “Dirty Startup”, “Clean Startup”, and “Resume” alarms.

TEMPERATURE

Variable Name	Default Deadband	Default Record	Source	Definition
TempPV(C)	0.200	✓	Calc	The temperature value detected by the software.
TempSP(C)	0.100	✓	User	The last temperature set point used when temperature was in Auto mode.

TEMPERATURE (continued)

Variable Name	Default Deadband	Default Record	Source	Definition
TempHeatDutyUser(%)	1.000	✓	User	The last user-defined heat duty used when temperature was in Manual mode.
TempModeActual	0.500	✓	Calc	The actual temperature mode: 0) Auto, 1) Manual, 2) Off, and 3) Sensor Error.
TempModeUser	0.500		User	The user-requested temperature mode: 0) Auto, 1) Manual, and 2) Off.
TempHeatDutyActual(%)	2.000	✓	Calc	The heat duty of the main heater.
TempA(C)	0.200		Calc	The PV reported by temperature sensor A.
TempARaw(C)	0.100		Sensor	The raw resistance temperature sensor A reports.
TempAlsActive	0.500		Calc	True when temperature sensor A has not failed.
TempInRange.A	0.500		Calc	True when temperature sensor A is in valid range.
TempHeatDutyControl.PGain(min)	0.001		System	See Temperature “P Gain (%/C)” setting in Appendix 1.
TempHeatDutyControl.ITime(min)	0.001		System	See Temperature “I Time (min)” setting in Appendix 1.
TempHeatDutyControl.DTime(min)	0.001		System	See Temperature “D Time (min)” setting in Appendix 1.
TempHeatDutyControlAlpha	0.001		System	See Temperature “Alpha” setting in Appendix 1.
TempHeatDutyControlBeta	0.001		System	See Temperature “Beta” setting in Appendix 1.

TEMPERATURE (continued)

Variable Name	Default Deadband	Default Record	Source	Definition
TempHeatDutyControl Gamma	0.001		System	See Temperature “Gamma” setting in Appendix 1.
TempHeatDutyControl Linearity	0.001		System	See Temperature “Linearity” setting in Appendix 1.
TempHeatManMax(%)	0.001		System	See Temperature “Heat Manual Max (%)” setting in Appendix 1.
TempHeatDutyAutoMax(%)	0.001		System	See Temperature “Heat Auto Max (%)” setting in Appendix 1.
TempValidMax(C)	0.001		System	See Temperature “Valid High (C)” setting in Appendix 1.
TempValidMin(C)	0.001		System	See Temperature “Valid Low (C)” setting in Appendix 1.